



UNICA™

USER GUIDE

UNICA 8M | 1K8 2K8 4K8 8K8
UNICA 4L | 5K4 9K4 12K4 16K4

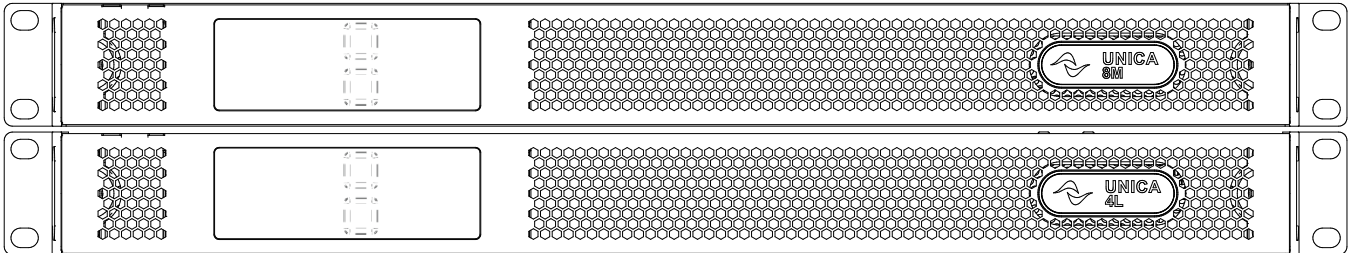







TABLE OF CONTENTS





















Introduction	6
Features summary	7
Overview	9
Front Panel	9
Rear Panel	10
Signal Flow	11
Installation	13
Rack mounting & cooling	13
Wiring	14
Fault Notification Output (STS)	15
Remote Standby	15
Master Level	15
GPIO	15
Configuration	16
Configuring Unica with ArmoníaPlus System Design Software	16
Network setup	17
Dante/AES67	18
Loudspeakers Preset	19
Loudspeakers Diagnostics	19
Standby and Eco Mode	20
GPIO	21
Snapshots	22
APIs and Third-Party Plugins	22
Cloud Monitoring	23
Operation	24
Front panel	24
Powersoft Cloud	31
Maintenance	34
Appendix	37
Network Security	37
PoE Features	37
Third-Party Plugins	38

Important Safety Instructions

Common symbols and meanings

-  THE TRIANGLE WITH THE LIGHTNING BOLT IS USED TO ALERT THE USER TO THE RISK OF ELECTRIC SHOCK.
-  THE TRIANGLE WITH THE EXCLAMATION POINT IS USED TO ALERT THE USER TO IMPORTANT OPERATING OR MAINTENANCE INSTRUCTIONS.
-  THE CE-MARK INDICATES THE COMPLIANCE OF THE PRODUCT TO ALL THE APPLICABLE EUROPEAN DIRECTIVES
-  SYMBOL FOR EARTH/GROUND CONNECTION.
-  SYMBOL INDICATING THAT THE EQUIPMENT IS FOR INDOOR USE ONLY.
-  SYMBOL FOR CONFORMITY WITH DIRECTIVE 2012/19/EC OF THE EUROPEAN PARLIAMENT ON WASTE ELECTRICAL AND ELECTRONIC EQUIPMENT (WEEE).

Safety Warnings

-  OPERATING TEMPERATURE RANGE: 0°C TO +50°C - DERATING ABOVE 35°C.
-  STORAGE RELATIVE HUMIDITY RANGE: 10% TO 85% HUMIDITY (NON CONDENSING).
-  DO NOT USE THE UNIT AT ALTITUDES ABOVE 2000 M.
-  DO NOT USE THE UNIT IN TROPICAL ENVIRONMENT.
-  TO REDUCE THE RISK OF ELECTRIC SHOCK, DO NOT ATTEMPT TO OPEN ANY PART OF THE UNIT. NO USER-SERVICEABLE PARTS INSIDE. REFER SERVICING TO QUALIFIED SERVICE PERSONNEL.
-  CONNECTION TO THE MAINS SHALL BE DONE ONLY BY A ELECTROTECHNICAL SKILLED PERSON ACCORDING THE NATIONAL REQUIREMENTS OF THE COUNTRIES WHERE THE UNIT IS SOLD.
-  FOR MODELS UNICA 4L | 16K4, UNICA 4L | 12K4, INSTALLATION IN CANADA / USA: PROTECTIVE EARTH CONDUCTORS MUST BE RELIABLY CONNECTED TO BUILDING EARTH BY A SKILLED PERSON ACCORDING TO THE REGULATORY REQUIREMENTS FOR CANADA AND USA.
-  DO NOT USE THIS AMPLIFIER IF THE ELECTRICAL POWER CORD IS FRAYED OR BROKEN.
-  TO AVOID ELECTRICAL SHOCK, DO NOT TOUCH ANY EXPOSED SPEAKER WIRING WHILE THE AMPLIFIER IS OPERATING.
-  DO NOT SPILL WATER OR OTHER LIQUIDS INTO OR ON THE AMPLIFIER.
-  THIS DEVICE MUST BE POWERED EXCLUSIVELY BY EARTH CONNECTED MAINS SOCKETS IN ELECTRICAL NETWORKS COMPLIANT TO THE IEC 364 OR SIMILAR RULES
-  DISCONNECT THE AC MAINS SOURCE BEFORE ATTEMPTING TO CLEAN ANY PART OF THE AMPLIFIER
-  PROPERLY FIT THE AC MAINS PLUG TO THE AMPLIFIER INLET. BEFORE POWERING THIS AMPLIFIER, VERIFY THAT THE CORRECT VOLTAGE RATING IS BEING USED.
-  TAKE CARE TO SECURE THE OUTPUT TERMINAL BEFORE SWITCHING THE DEVICE ON.
-  FOR ALL MODELS EXCEPT UNICA 4L | 16K4, UNICA 4L | 12K4: POWERSOFT SUGGESTS TO PLUG THE UNIT TO A 16 A RATING, C OR D CURVE, 10 KA SECTIONING BREAKER.
-  FOR MODELS UNICA 4L | 16K4, UNICA 4L | 12K4: POWERSOFT SUGGESTS TO PLUG THE UNIT TO A 20 A RATING, C OR D CURVE, 10 KA SECTIONING BREAKER.
-  OUTPUT TERMINALS ARE HAZARDOUS: WIRING CONNECTION TO THESE TERMINALS REQUIRES CLASS 3 WIRING INSTALLATION BY AN INSTRUCTED PERSON AND THE USE OF READY MADE LEADS.
-  VERIFY THAT YOUR MAINS CONNECTION IS CAPABLE OF SATISFYING THE POWER RATINGS OF THE DEVICE.
-  NO NAKED FLAME SOURCES SUCH AS LIGHTED CANDLES SHOULD BE PLACED ON THE AMPLIFIER.
-  IT IS HIGHLY RECOMMENDED TO UNPLUG THE OUTPUT CONNECTORS BEFORE PROCEEDING WITH THE SELF CHECK PROCEDURE
-  THE TESTING SIGNALS MIGHT CAUSE LOUDSPEAKER IMPAIRMENTS.
-  TO PREVENT INJURY, THIS APPARATUS MUST BE SECURELY RACK MOUNTED IN ACCORDANCE WITH THE INSTALLATION INSTRUCTIONS.
-  THE MANUFACTURER CANNOT BE HELD RESPONSIBLE FOR DAMAGES CAUSED TO PERSONS, THINGS OR DATA DUE TO AN IMPROPER OR MISSING GROUND CONNECTION.
-  IT IS ABSOLUTELY NECESSARY TO VERIFY THESE FUNDAMENTAL REQUIREMENTS OF SAFETY AND, IN CASE OF DOUBT, REQUIRE AN ACCURATE CHECK BY QUALIFIED PERSONNEL.
-  THIS EQUIPMENT SHALL BE MOUNTED AT A MAXIMUM HEIGHT OF 2 METERS



Please read and keep all safety and use instructions.

This product is intended for installation by professional installers only! This document is intended to provide professional installers with basic installation and safety guidelines for this product in typical fixed-installation systems. Please read this document and all safety warnings before attempting installation.

1. Read these instructions.
2. Keep these instructions.
3. Heed all warnings.
4. Follow all instructions.
5. Do not use this equipment near water.
6. Clean only with a dry cloth.
7. Do not block any ventilation openings. Install in accordance with the manufacturer's instructions.
8. Do not install near any heat sources such as radiators, heat registers, stoves, or other apparatus that produce heat.
9. Do not defeat the safety purpose of the polarized or grounding-type plug. A polarized plug has two blades with one wider than the other. A grounding-type plug has two blades and a third grounding prong. The wide blade or the third prong are provided for your safety. If the provided plug does not fit into your outlet, consult an electrician for replacement of the obsolete outlet.
10. Protect the power cord from being walked on or pinched particularly at plugs, convenience receptacles, and the point where they exit from the apparatus.
11. Only use attachments/accessories specified by the manufacturer.
12. Use only with the cart, stand, tripod, bracket, or table specified by the manufacturer, or sold with the apparatus. When a cart is used, use caution when moving the cart/apparatus combination to avoid injury from tip-over. 
13. Unplug this apparatus during lightning storms or when unused for long periods of time.
14. Refer all servicing to qualified service personnel. Servicing is required when the apparatus has been damaged in any way, such as power-supply cord or plug is damaged, liquid has been spilled or objects have fallen into the apparatus, the apparatus has been exposed to rain or moisture, does not operate normally, or has been dropped.

Warranty and Technical Service

This product is covered by a limited warranty.

 This Powersoft product contains no user-serviceable parts. All warranty repairs must be carried by a certified technician operating in a Powersoft Authorized Service Centre.

Contact The Authorized Service Center For Ordinary And Extraordinary Maintenance. To learn more about warranty terms and conditions, visit powersoft.com/warranty
For any service related enquiry, please visit powersoft.com/en/product-repair/

EC Declaration Of Conformity

Regulatory Compliance Statements

Europe

If the time arises to dispose of your product, please recycle all possible component. This symbol indicates that when the end-user wishes to discard this product, it must be sent to separate collection facilities for recovery and recycling. By separating this product from other household-type waste, the volume of waste sent to incinerators or land-fills will be reduced and natural resources will thus be conserved.



The Waste Electrical and Electronic Equipment Directive (WEEE Directive) aims to minimise the impact of electrical and electronic goods on the environment. Powersoft S.p.A. comply with the Directive 2012/19/EU of the European Parliament on waste electrical and electronic equipment (WEEE) in order to reduce the amount of WEEE that is being disposed of in land-fill site. All of our products are marked with the WEEE symbol; this indicates that this product must NOT be disposed of with other waste. Instead it is the user's responsibility to dispose of their waste electrical and electronic equipment by handing it over to an approved reprocessor, or by returning it to Powersoft S.p.A. for reprocessing. For more information about where you can send your waste equipment for recycling, please contact Powersoft S.p.A. or one of your local distributors.

USA

FCC Supplier's Declaration of Conformity

Responsible Party:
Powersoft S.p.A.
Via Enrico Conti, 5
50018 Scandicci (FI) – Italy
Phone: +39 055 735 0230
Fax: +39 055 735 6235

FCC Compliance Statement

This device complies with part 15 of the FCC rules. Operation is subject to the following two conditions:

- 1) This device may not cause harmful interference, and
- 2) this device must accept any interference received, including interference that may cause undesired operation.

CAUTION: Changes or modifications not expressly approved by the party responsible for compliance could void the user's authority to operate the equipment.

NOTE: This equipment has been tested and found to comply with the limits for a Class A digital device, pursuant to part 15 of the FCC Rules. This equipment generates, uses, and can radiate radio frequency energy and, if not installed and used in accordance with the instruction manual, may cause harmful interference to radio communications. However, there is no guarantee that interference will not occur in a particular installation. If this equipment does cause harmful interference to radio or television reception, which can be determined by turning the equipment off and on, the user is encouraged to try to correct the interference by one or more of the following measures:

- Reorient or relocate the receiving antenna.
- Increase the separation between the equipment and receiver.
- Connect the equipment into an outlet on a circuit
- Different from that to which the receiver is connected.

WARNING: This is a class A product. In a domestic environment this product may cause radio interference in which case the user may be required to take adequate measures

Canada

Canadian Caution

This device contains licence-exempt transmitter(s)/receiver(s) that comply with Innovation, Science and Economic Development Canada's licence-exempt RSS(s). Operation is subject to the following two conditions:

- 1) This device may not cause interference.
- 2) This device must accept any interference, including interference that may cause undesired operation of the device.

WARNING: This is a class A product. In a domestic environment this product may cause radio interference in which case the user may be required to take adequate measures

ICES-003 Class A Notice

This Class A digital apparatus complies with Canadian ICES-003.

Radiation Exposure Statement

This equipment complies with RSS-102 radiation exposure limits set forth for an uncontrolled environment. This equipment should be installed and operated with minimum distance 20cm between the radiator & your body.

Manufacturer:
Powersoft S.p.A.
via E. Conti 5
50018 Scandicci (Fi)
Italy



We declare that under our sole responsibility the products:

Model Names:

Unica 4L 5K4	Unica 8M 1K8
Unica 4L 9K4	Unica 8M 2K8
Unica 4L 12K4	Unica 8M 4K8
Unica 4L 16K4	Unica 8M 8K8

Intended use: Professional Audio Amplifier

Are in conformity with the provisions of the following EC Directives, including all amendments, and with national legislation implementing these directives:

2014/35/EU	Low Voltage Directive
2014/30/EU	Electromagnetic Compatibility Directive
2011/65/EU	RoHS Directive

The following harmonized standards are applied:

EN 55032:2015,
EN 55032:2015/A11:2020
EN 55035:2017,
EN 55035:2017/A11:2020
EN 61000-3-2:2014
EN 61000-3-3:2013
EN 61000-3-11:2000
EN 62368-1:2014
EN 62368-1:2014/AC:2015

Scandicci,
Dec 2023

Marco Cati
Quality & After Sales Manager

For compliance questions only: compliance@powersoft.it

INTRODUCTION

Welcome

Thank you for choosing Powersoft Unica series amplifiers.

Unica amplifiers deliver pristine sound in a compact, high-power and high channel-dense format to a wide range of fixed-install applications, with uncompromised audio quality, efficiency, and reliability. This document provides users with amplifier installation instructions, key features description and configuration methods, and operation and maintenance guidelines.

The information contained in this guide applies to all Unica series amplifier models (Unica 4L | 5K4/9K4/12K4/16K4, Unica 8M | 1K8/2K8/4K8/8K8). This user guide is meant to help professionals during the design, installation, configuration, operation, and maintenance of a project employing Unica amplifiers. However, it does not cover all possible applications and use cases. Please contact your local dealer or a technical support specialist for more information and assistance.

Unica Series

The Unica Series is an advanced and innovative amplifier platform, featuring Powersoft's 3rd generation amplification and processing technology. It includes four-channel and eight-channel models, all with a one-rack-unit form factor, processing, and feature set for maximum consistency. Three RJ45 ports on the rear panel enable flexible control and Dante/AES67 connectivity, allowing for a variety of networking topologies. The Unica series comprises eight different models, delivering a total power of up to 16kW for the four-channel, and up to 8kW for the eight-channel. All models are equipped with a PoE input for DSP power backup and uninterrupted diagnostics. Additionally, the onboard internet gateway makes Unica the first Cloud-native amplifier platform by Powersoft, allowing for remote monitoring from any device, anywhere in the world.

The table below summarises the key aspects of Unica series amplifier models:

Model	Total Rated Power	Channels	Power per Channel @ 4 Ω (symmetrical)	Power per Channel @ 4 Ω (Maximum Power Sharing capability)	Networking
Unica 4L 16K4	16 kW	4	4000 W	5200 W	Dante/AES67
Unica 4L 12K4	12 kW	4	3000 W	4000 W	Dante/AES67
Unica 4L 9K4	9 kW	4	2250 W	3200 W	Dante/AES67
Unica 4L 5K4	5 kW	4	1250 W	1800 W	Dante/AES67
Unica 8M 8K8	8 kW	8	1000 W	2000 W	Dante/AES67
Unica 8M 4K8	4 kW	8	500 W	1000 W	Dante/AES67
Unica 8M 2K8	2 kW	8	250 W	500 W	Dante/AES67
Unica 8M 1K8	1 kW	8	125 W	250 W	Dante/AES67

Features summary

Unica amplifier series

Eight amplifier models ensure enough power and channel count options to fulfill a wide range of requirements in fixed install applications. The Unica Series includes four and eight channel models, with total power ranging from 5kW to 16kW for the four channels, and from 1kW to 8kW for the eight channels, all in a consistent one rack-unit form factor.

Powersoft 3rd Generation amplification technology

State-of-the-art processing and amplification architecture ensure maximum audio performance and reliability, allowing for advanced processing, networking, and monitoring capabilities to meet the growing needs and complexity of audio systems.

Networking

Three configurable 1Gb ports allow daisy-chain as well as Dante-redundant network topologies, via two operating modes: Switched and Split-Redundant. The Split-Redundant mode allows one port dedicated to control and two ports for Dante/AES67, allowing network traffic separation. Lastly, a dedicated network-security webpage allows advanced configuration to meet stringent network-security requirements.

PoE input

The PoE input allows keeping the network ports and amplifier logic circuitry powered in case of mains loss, ensuring a short wake-up time when power is restored. The Unica Series also allows monitoring the loudspeakers and amplifier outputs circuitry without mains, when powered by PoE++.

Power Sharing

Each output can deliver up to twice the rated power when asymmetrically loaded, ensuring high versatility during the system design and spec'ing phase. Additionally, each output can drive both 70/100V and low impedance loudspeakers down to two ohms seamlessly, without the need to configure the output mode. Output channels can be bridged and feature extensive loudspeaker diagnostic tools.

Front panel display

Access to the amplifier's status and general information is granted via the front panel LCD display, which is useful for troubleshooting, monitoring, and maintenance purposes.

ArmoníaPlus Software

All models include network connectivity and onboard processing. It is possible to adjust each amplifier parameter, loading speaker presets, and tune complex systems easily thanks to Powersoft ArmoníaPlus software.

Eco Mode

Automatic energy-saving functionality allows turning off each output channel independently when audio is not passing, minimizing energy consumption. Channels are individually and instantaneously turned on as soon as a signal is detected, without impacting audio performance.

Integration protocols

Comprehensive third-party control protocols allow integration with third-party system processors for control, monitoring, and automation via purpose-built plugins and APIs.

Easy Swap

Game-changing functionality allows replacing an amplifier quickly, without product-specific knowledge and independent of system size and complexity. This is possible thanks to Unica's ability to store backups on a local USB flash memory drive, and restore the backup to a replacement amplifier by simply inserting the USB drive and following the procedure on the front-panel display.

Load Impedance

Each amplifier output can measure the impedance curve of the loudspeakers connected, both low and high impedance, thanks to accurate output voltage and current sensing. The result of the load impedance measurement can be used to diagnose if the loudspeakers are behaving as expected.

Cloud

The cloud-native connectivity allows remote monitoring of the amplifier status from any device, anywhere in the world, via the Powersoft Cloud.

OVERVIEW

Front Panel

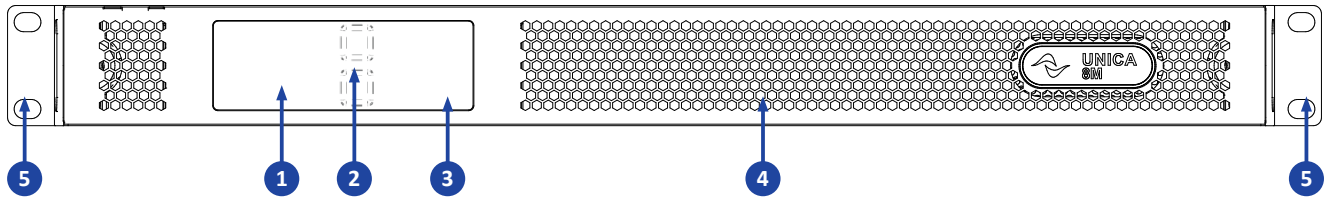

1. **LCD screen**, displaying the amplifier status and information.
2. **Touch buttons**, for screen navigation (up, down).
3. **RGB LEDs indicators**
 - STATUS, for amplifier's status indication.
 - NETWORK, for indication of network connectivity status.
 - SIGNAL, for input signal presence and output limiting indication.
4. **Front grille and dust filter holder** for front air intake, removable.
5. **Rack mount ears**, for 19inch racks.

Rear Panel

Four Channel Models

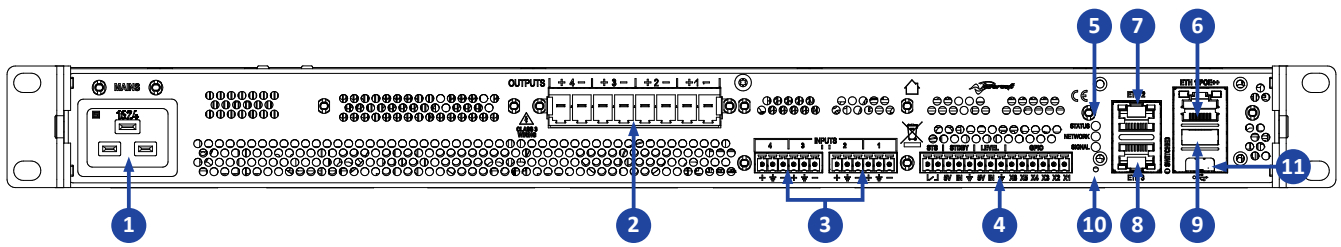

Eight Channel Models

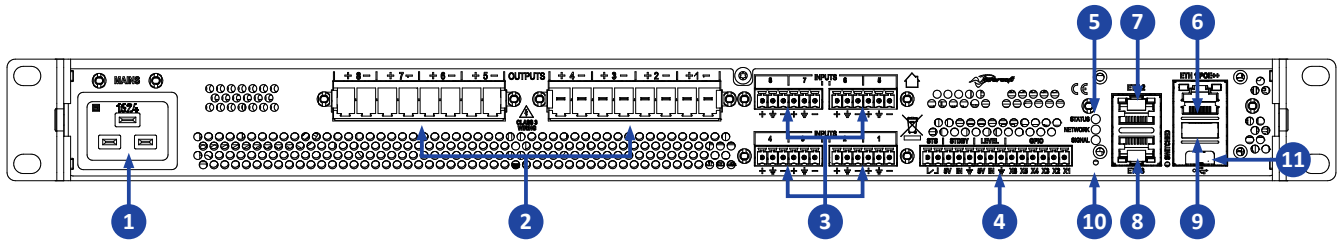

1. AC Mains input

2. Amplifier outputs

3. Analog inputs

4. Control and monitor connector:

- STS, for critical alarms notification output (contact closure, normally closed).
- STDBY input, for remote amplifier standby.
- LEVEL input, for controlling the level of all amplifier outputs.
- GPIO pins, user-configurable (see [GPIO section](#) for more details).

5. RGB LEDs indicators

- STATUS, for amplifier's status indication.
- NETWORK, for indication of network connectivity status.
- SIGNAL, for input signal presence and output limiting indication.

6. Ethernet RJ-45 connector for control and Dante/AES67 network connectivity and PoE operations.

7. Ethernet RJ-45 connector for control and Dante/AES67 network connectivity.

8. Ethernet RJ-45 connector for control and Dante/AES67 network connectivity. (see [Network Setup section](#) for more details).

9. USB Type A port, for Easy Swap local backup storage. (see [Easy Swap section](#) for more details).

10. Reset.

11. USB Type C port, reserved for service.

Signal Flow

All Unica series amplifier models share the same signal flow and processing architecture, as highlighted in the figure below.

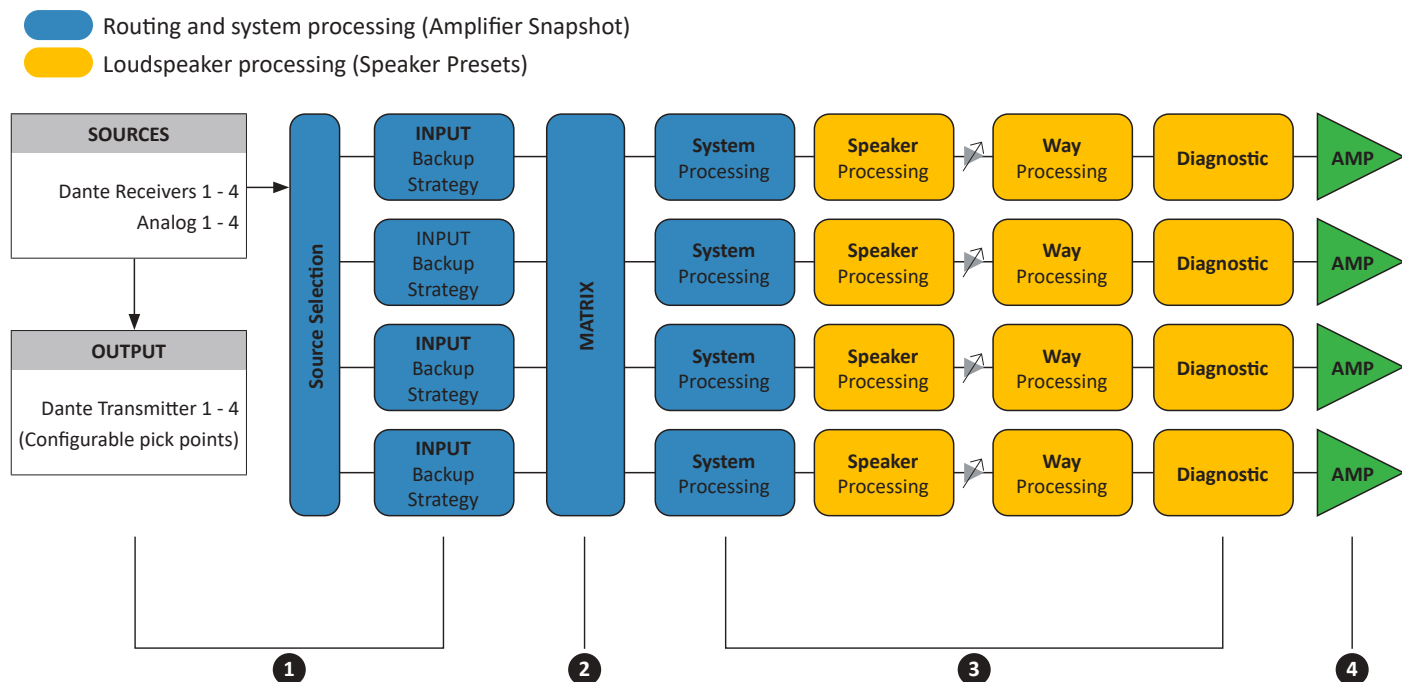

Signal flow of a four-channel Unica series amplifier.

Eight-channel models share the same architecture but feature eight channels instead of four.

1 Inputs

Four and eight channel models of Unica features four or eight input modules respectively, allowing configuring up to four backup sources per each input, with different priorities. The backup strategy functionality allow automatic switchover of inputs in case of failure according to two different strategies, Signal Presence or Pilot tone, as highlighted below:

Signal presence

When the amplifier is configured for backup strategy based on signal presence, the amplifier automatically plays the next-priority source in case the higher-priority source stop playing. The typical application is that of an analog input configured to backup a Dante/AES67 source. In the event of a failure of the Dante/AES67 network, the amplifier play the analog input automatically as soon as signal presence on Dante/AES67 is not detected.

Pilot tone

When configured for backup strategy based on pilot tone, the amplifier automatically play the higher-priority input that shows a pilot tone at a given frequency and level settings. The typical application is that of an analog/digital input configured to play announcements (embedding a pilot tone) with a higher priority compared to other sources, in this case the amplifier play the announcement input as soon as the pilot tone is detected, and switches back to the lower-priority input when the announcement finishes. The input pilot tone detection can also be used to trigger alarms in case the pilot tone is not present on the connected sources, allowing monitoring the signal distribution infrastructure (analog cables, network infrastructure).

It is possible to disable the input backup strategy by setting it to **Manual (Force)**. This will ensure that the amplifier will always play the configured source.

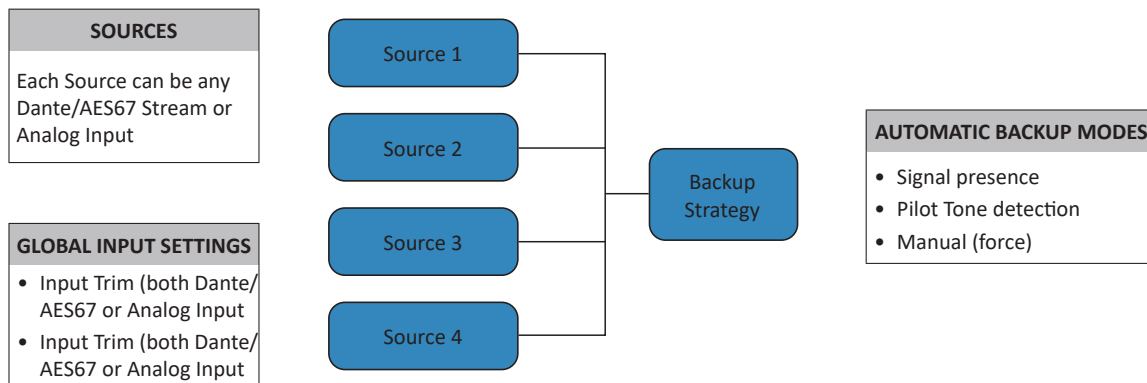

Input and backup strategy architecture

2 Matrix

The matrix connects the input to the loudspeakers. Each matrix tap provides continuous gain control from 0dB to $-\infty$, allowing simple routing as well as mixing two or more inputs.

3 Output processing

Each amplifier output provides both loudspeaker and system-level processing.

The loudspeaker processing include extensive EQ and Limiting capabilities, making Unica series amplifiers suitable to accurately drive and monitor the status of any modern loudspeaker, while ensuring compatibility with Powersoft's extensive Speaker Preset library. The system processing allow for complex system tuning via ArmoníaPlus software, thanks to loudspeaker grouping capabilities and streamlined workflow.

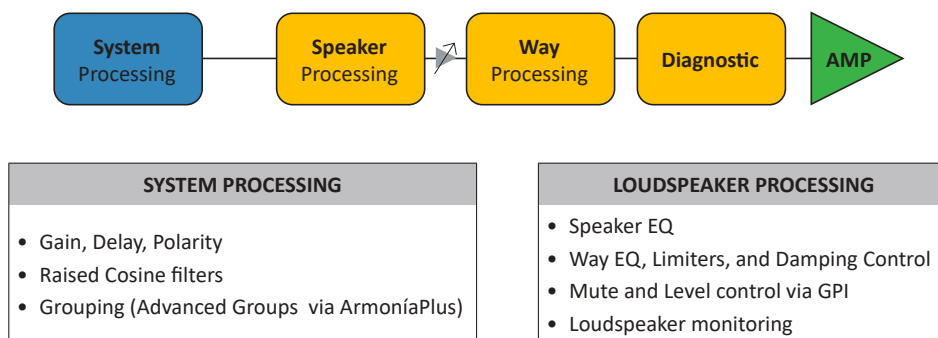

Output processing architecture

4 Amplifier outputs

Unica series amplifiers are designed to provide professional-grade power to high channel dense systems. Each output can deliver up to twice the rated power when asymmetrically loaded, and can seamlessly drive both 70/100V and low impedance loudspeakers down to two ohms without the need for configuration. Output channels can be bridged and feature extensive loudspeaker diagnostic tools for easy troubleshooting.

INSTALLATION

Unboxing

The Unica platform has been completely tested and inspected before leaving the factory. Carefully inspect the shipping package before opening it, and then immediately inspect your new product. If you find any damage, immediately notify the reseller.

The box contains the following:

- 1x Unica Series amplifier platform
- 1x AC mains cable (region specific)
- 1x AC mains cable retainer
- 1x Connectors kit
- 2x Rack mount extensions
- 1x User Guide

Rack mounting & cooling

We recommend securing the Unica platform into a suitable 19" rack cabinet, using all provided mounting points, and leaving an empty slot every 4 units to allow adequate cooling.

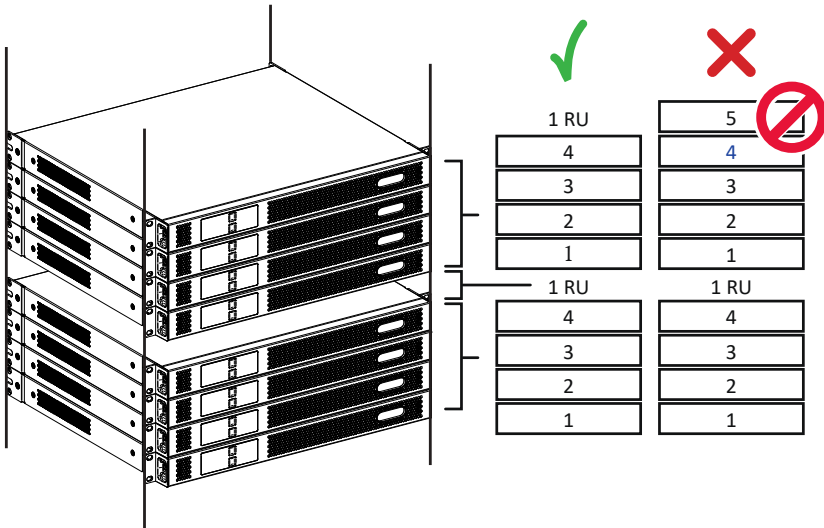

Secure both front and rear mounting points to the rack. If needed, you can fit the included rack mount extensions to the chassis.

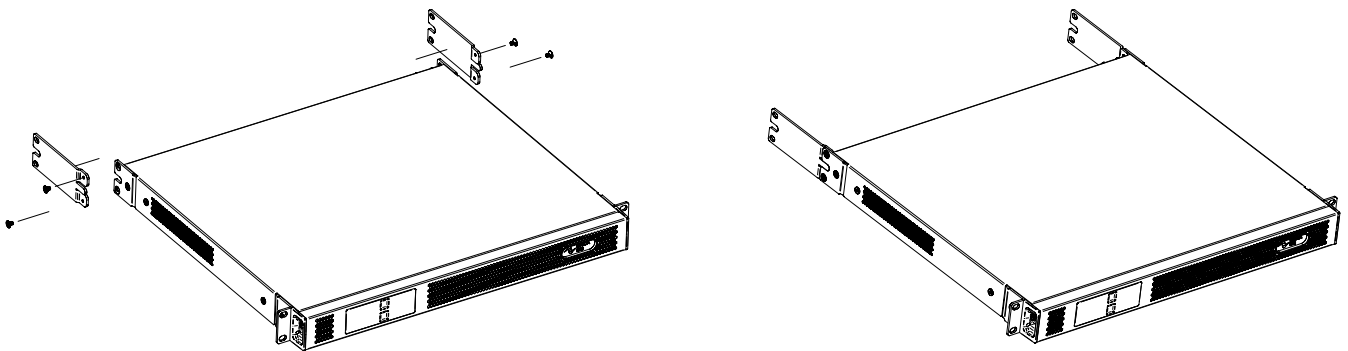

The Unica platform features a forced front-to-back air cooling system: fresh air enters the front of the amplifier, and hot air is exhausted at the rear and through the openings on the sides.

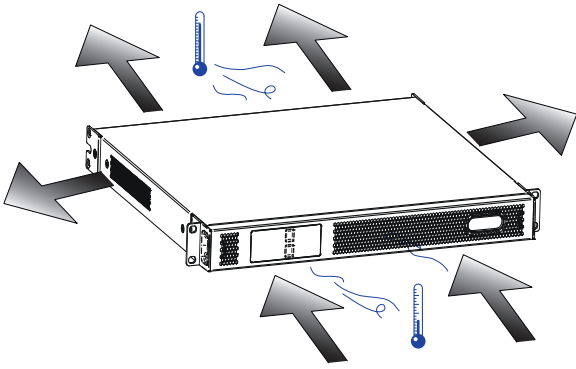

Wiring

Input

Phoenix MC 1,5/6-ST-3,81

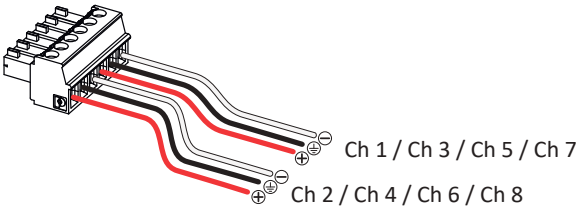

Output

Phoenix PC 5/8-STF1-7,62

Single Ended (Flipped view)

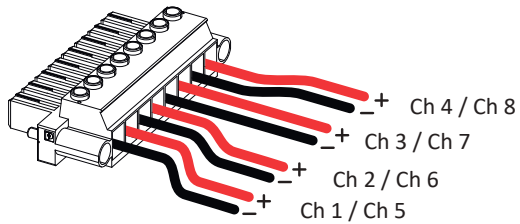

Bridged (Flipped view)

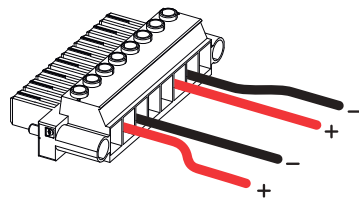

Mains

IEC C19

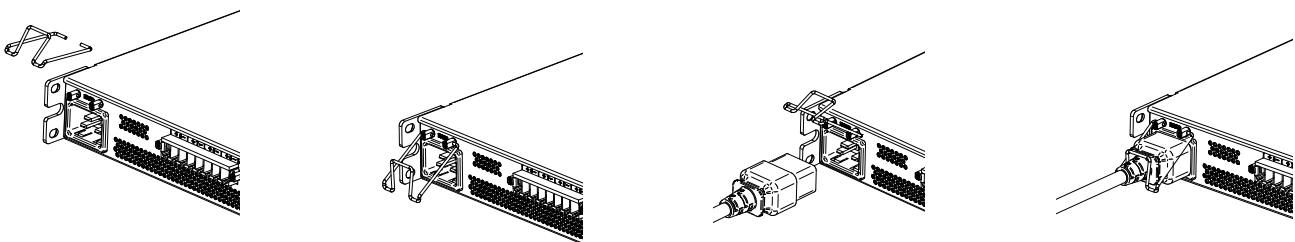

Network

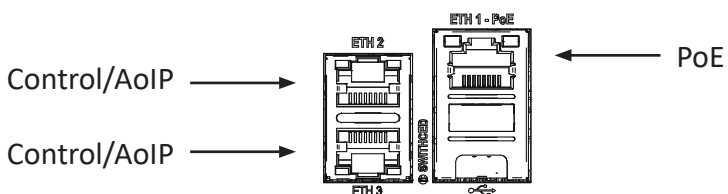

For more details check the [white paper](#) on our website.

Fault Notification Output (STS)

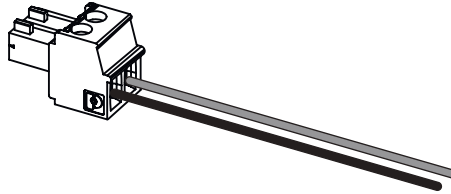

The STS output can be used to connect the Unica platform to remote monitoring system for fault notification purposes.

The contact is designed to be in the closed position while the amplifier is in normal operating conditions. However, it will switch to the open position when the amplifier is turned off, in standby mode, or when a fault is detected that prevents the amplifier from functioning properly.

Remote Standby

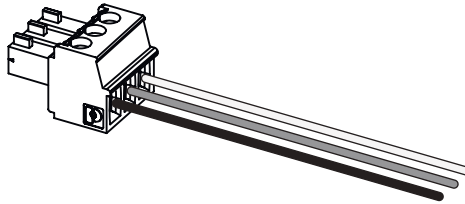

The Remote Standby input is utilized to put the amplifier into standby mode. This can be achieved by supplying the remote standby pin (STBY IN) with 5Vdc. The remote standby pins also provide a +5Vdc supply, enabling the use of an external dry contact to switch the amplifier on and off. Alternatively, an external device can supply the +5Vdc signal to put the amplifier into standby mode, provided that the Ground is connected between the amplifier and the external device.

Master Level

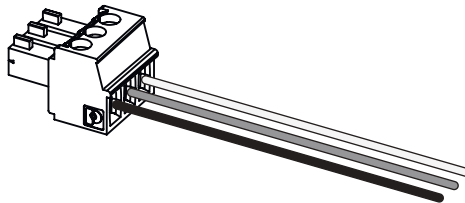

The Master Level input enables control of the level of all amplifier outputs through a voltage input (VCA) ranging from 0dB to approximately -60dB (mute). The LEVEL IN pin allows for input ranging from 0 to +5Vdc, where 0Vdc sets the amplifier outputs to -60dB (mute), and a +5Vdc input sets the amplifier outputs to 0dB attenuation.

GPIO



Each GPIO pin can be configured individually as an input, output, GND, or +5Vdc. For more information on how to configure GPIO, please refer to the [GPIO](#) section.

CONFIGURATION

This section provides an overview of the ways Unica can be configured and the steps necessary to set up the amplifier.

Configuring Unica with ArmoníaPlus System Design Software

ArmoníaPlus System Design Software is a powerful yet intuitive software for configuring, controlling and monitoring Powersoft products. With ArmoníaPlus, users can set up their audio system quickly and easily, from the installation of the products to the configuration of their parameters. The ArmoníaPlus software can be downloaded from the Powersoft website.

To configure Unica series amplifiers with ArmoníaPlus System Design software, the amplifier must be connected to the same network as the PC running the software.

Once the network connection is established, the amplifier can be connected to the software via the **Match** procedure in two ways:

1. Open the **Design → Match** screen on ArmoníaPlus and click the **Discovery** button in the top right corner. The amplifier should appear in the list of online devices. To control the amplifier, drag it onto the workspace or click the **Add All** button in the top right corner of the screen.
2. Open the **Design → Add** screen on ArmoníaPlus and click on **Amplifier**, in the top left corner. From here, navigate the devices library by clicking on **Powersoft → Unica Series**. Select the correct amplifier model from the list and click **Add & Close**. Now go to the **Design → Match** screen on ArmoníaPlus and click **Discovery**. The real amplifier will show up in the list of online devices. From here it is possible to:
 - a. Drag and drop the discovered amplifier to its virtual counterpart on the workspace.
 - b. Click on the virtual amplifier icon on the workspace, and then press either of the two buttons on the front panel of the amplifier. This will complete the match operation automatically, allowing the amplifier to be remotely controlled.

Once the match operation is successful, it will be indicated by three flashing white LEDs on the front panel and a change in the display brightness. Through the match operation, ArmoníaPlus will be able to access and control all device parameters, including DSP settings, AoIP input patch and output settings, Standby and Eco mode settings, and GPIO settings. For more information on matching virtual and physical devices, as well as other ArmoníaPlus tutorials, please visit our YouTube channel.

Network setup

Unica is equipped with three Ethernet ports: **Eth-1**, **Eth-2**, and **Eth-3**. These ports can be configured to operate in either **Switched** or **Split Redundant** mode according to the specific target application, through the use of ArmoníaPlus.

In **Switched Mode**, the three ports behave as a network switch, allowing for daisychain of multiple units. In this mode, the amplifier has one IP address for both Control and Dante, which defaults to DHCP mode. Switched Mode is the default network setup for amplifiers right out of the box, or after a network reset/factory reset procedure has been completed.

In **Split Redundant Mode**, each port has its own unique settings, allowing for separating the control traffic on **Eth-1** from the **Dante/AES67** traffic on **Eth-2** and **Eth-3** (where port 2 and 3 allow for Dante redundant network topology). The default IP settings for all three ports is DHCP.

To configure the network settings of Unica amplifiers via ArmoníaPlus, access the device details page by selecting the cursor option in Workspace view and double clicking the device. From the left-hand panel, select **Options** and then **Networking**.

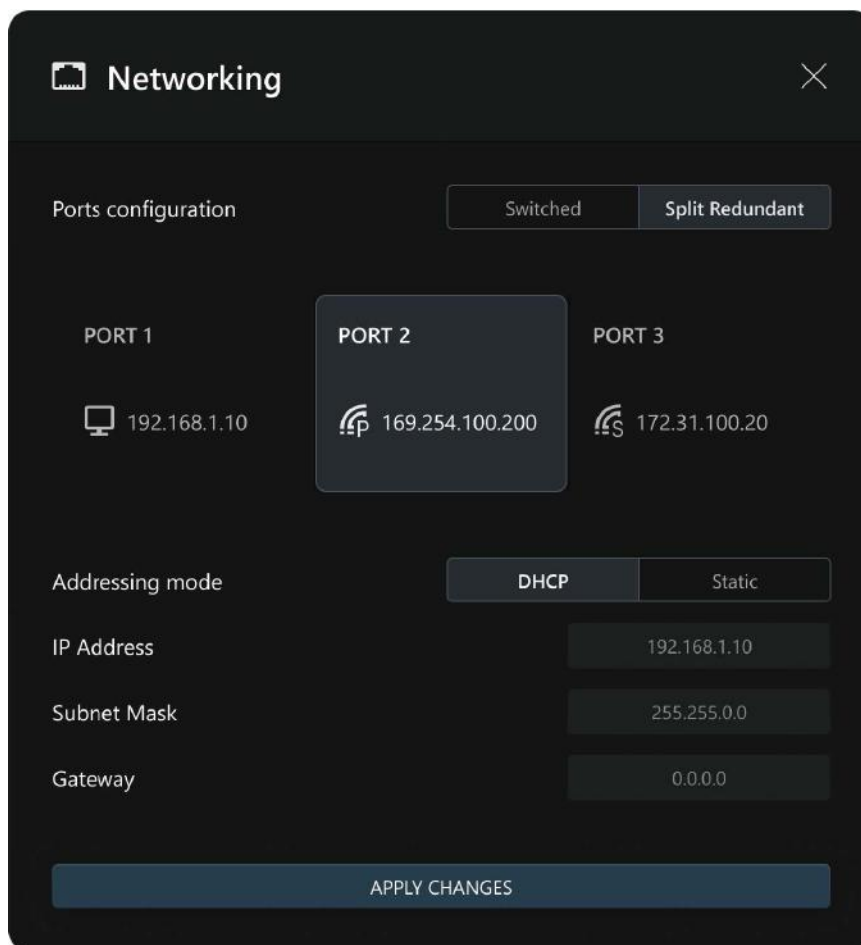

Network Setup panel

Dante/AES67

Dante is a digital audio networking protocol developed by Audinate, designed to transfer audio over IP networks with low latency and high quality. Easy to use and integrate with existing networks, Dante allows users to route audio on one network and access/control multiple audio sources. It is interoperable with other protocols such as AES67 and offers built-in redundancy and remote control/monitoring.

Dante Inputs

The Unica series amplifiers are equipped with Dante as their native audio over IP onboard. Depending on the model – whether it is a four-channel or an eight-channel amplifier – they can provide either 4 or 8 Dante inputs, and up to 4 or 8 Dante flows respectively. Users can patch Dante/AES67 audio inputs of the amplifier to Dante/AES67 sources in the same network using the Dante Controller or conveniently within the ArmoníaPlus software. For more information on patching Dante input channels to Unica series amplifiers, as well as other ArmoníaPlus tutorials, please visit our YouTube channel for instructional videos.

Dante Outputs

Unica amplifiers can be configured to transmit Dante/AES67 channels for various applications, such as analog-to-digital conversion or driving other amplifiers or loudspeakers with line-level audio signals. Taking advantage of Unica onboard loudspeaker and system processing, digital audio can be sent from the amplifier over the Dante network through one or more of the following pick-points:

- Physical inputs, such as any of the analog input channels
- Matrix inputs, such as any of the post-source selection matrix inputs
- Matrix outputs, such as any of the matrix outputs
- Ways out, such as any of the post-processing amplifier outputs

By default, Dante transmission is done in unicast, meaning that one transmission flow can only be received by one Dante device. The Dante Controller can be used to configure multicast flows and AES67 streams, allowing up to 4 or 8 output channels per flow, depending on the amplifier model.

Configuring Dante via Powersoft ArmoníaPlus software

In the ArmoníaPlus interface, it is possible to edit the Dante device name, Dante latency (1, 2, 3, 4, 5, or 10 ms), sample rate (48 or 96 kHz), and the AES67 mode.

Advanced Dante settings configuration can be done through the Audinate Dante Controller software.

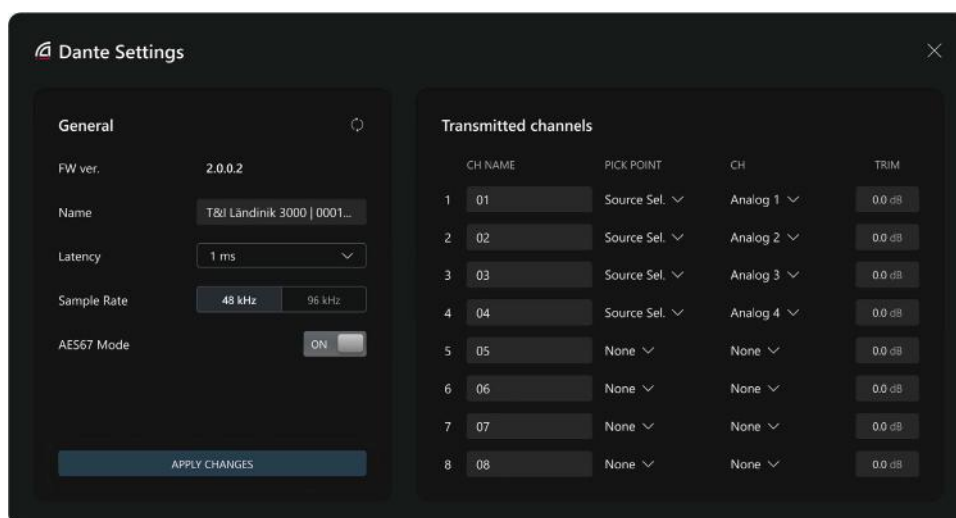

Dante Settings panel

Loudspeakers Preset

Unica amplifiers come with a library of loudspeaker presets that can be accessed through ArmoníaPlus System Design software. These presets are designed to provide optimised performance for a range of loudspeaker models, making it easier for users to quickly set up the system. The presets parameters typically include include loudspeaker type, EQ, Crossovers, and protection Limiters.

In addition to the loudspeaker presets distributed via ArmoníaPlus software, users can also create their own custom presets. This can be done by accessing the amplifier's internal DSP properties in ArmoníaPlus and then selecting the **Speaker Configuration** icon. For more information on how to load and create loudspeaker presets, please visit our website or Youtube channel.

Loudspeakers Diagnostics

Unica amplifiers are equipped with a suite of diagnostic tools to help users monitor the health of connected loudspeakers. To access the diagnostic tools, select the device in the Workspace menu in ArmoníaPlus software, double-click it to open the device menu, and then select **Way Output → Diagnostics**. From there, it is possible to configure the following:

- **Pilot Tone Load Monitor.** This tool allows users to configure each output to generate a pilot tone of a specific frequency and level. This pilot tone can be used to monitor the status of distributed loudspeaker systems. If the impedance measured at the pilot tone frequency is outside of the range specified by the user, alarm notifications will be triggered.
- **Load Impedance Detector.** The user can configure the amplifier outputs to monitor the average impedance of the connected loudspeaker, which is beneficial for loudspeaker cabinets with low impedance. It is important to note that average impedance is only measured when an audio signal is present on the outputs; thus, average impedance is not available when the amplifier is in an idle state. If the measured impedance is outside of the user-defined range, alarms will be triggered.

To measure the complex impedance of connected loudspeakers, open the **Workspace menu** in ArmoníaPlus software, double-click the device, select **Way Output → Load Impedance**, and click the **Automated Impedance Measurement** button.

This will generate a reference signal and measure the impedance of the connected loudspeaker within the loudspeaker passband.

The Unica series amplifiers are equipped with Power over Ethernet (PoE) input, enabling the amplifier to power the output channels with enough energy to run the Load Impedance and Loudspeaker diagnostic tools without the need for a mains power source (PoE++, Class 8, 90W required).

Standby and Eco Mode

The Unica amplifiers are able to operate in three modes: **Powered**, **Standby**, and **Eco**. The **Powered** mode is enabled by default and allows the amplifier to be fully powered, operational, and ready to produce audio through its outputs. The other two modes, **Standby** and **Eco**, may be enabled as needed.

Standby Mode

Unica amplifiers provide a standby mode which allows saving the most energy while still ensuring short wake up times and continuous monitoring. There are two methods to enable Standby mode:

In ArmoníaPlus under the **Options** section of the device page, select “edit” of the General options widget and turn on the standby button.

By amplifier Standby pin: Applying and maintaining a differential voltage on the standby pin on the amplifier’s rear panel. Note that the amplifier cannot be removed from standby via ArmoníaPlus as long as a differential voltage is applied to the amplifier Standby pin.

Eco Mode

Unica amplifiers have an energy-saving feature called Eco Mode. This feature allows each output channel to be automatically turned off when no audio is passing through, minimising energy consumption. When audio is detected, the channels will be instantly turned on without affecting audio performance. Eco Mode is enabled by default, and can be enabled or disabled via ArmoníaPlus.

To enable or disable Eco Mode in ArmoníaPlus, do the following:

1. In the Workspace, select the cursor option and double-click on the device to access its Device DSP parameters.
2. From the left panel, select “Options”, then “Edit” in the General options widget.
3. Here you can turn the Eco Mode switch on or off.

When the output channel has been in Eco Mode for 10 minutes without any signal, it can be brought back to full operational mode either by having a signal present in the matrix output channel or by disabling the entire functionality.

GPIO

Unica Series amplifiers are equipped with six **General Purpose Input/Output (GPIO)** pins which can be configured for a range of pre-defined uses, via ArmoníaPlus software. By default, these pins are inactive.

Users can configure any GPIO pin to operate as:

- Loudspeaker VCA input
- Loudspeaker Mute input
- Digital output
- Constant 5V output
- Ground

When configured as **VCA input**, a GPI pin can be used to provide attenuation for any loudspeaker or group of loudspeakers connected to the amplifier's outputs.

When configured as **Mute Input**, the GPI pin can be used to mute individual or groups of loudspeakers. When configured in this way, the loudspeakers connected to the GPIO pin will be muted as long as the pin is set to 1. The loudspeaker mute will revert to its previous state when the pin is set to 0.

When configured as **Outputs**, GPO pins can be used to monitor the status of the amplifier, of the connected loudspeakers, or any pilot tone applied to the amplifier inputs.

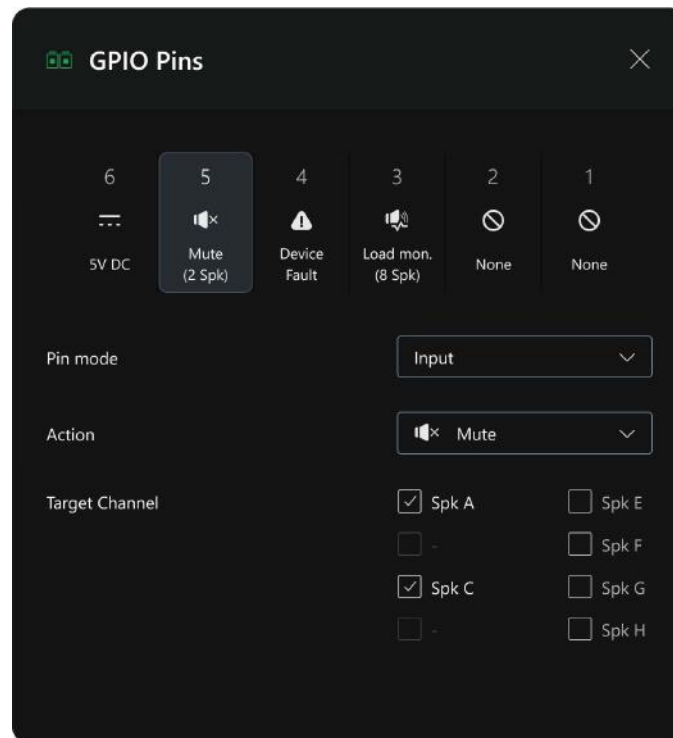

GPIO Configuraiton panel

Snapshots

The onboard memory of the amplifier is designed to store **Snapshots**, providing a convenient way to recall pre-defined sets of parameters for applications that require frequent reconfiguration, such as a sports bar hosting live music events. It can store up to **50 Snapshots** which can be saved and recalled through ArmoníaPlus. These parameters include **DSP settings, AoIP input patch and output settings, Standby and Eco mode settings, and GPIO settings**. Parameters that are not saved include **Groups, Ethernet Configuration, and Dante Parameters**. Recalling an amplifier Snapshot can be also conveniently done via third-party API. Note that after a factory reset, all Snapshots are deleted.

APIs and Third-Party Plugins

Unica series amplifiers provide APIs and third-party plugins for developers to create custom-tailored integrations for their projects. The APIs provide an interface to enable communication between the amplifier and other devices, allowing for the control of multiple parameters such as DSP settings, AoIP input patch and output settings, Standby and Eco mode settings, GPIO settings, and more. From the ability to create custom-tailored integrations to a range of specialized and advanced functions, Unica series APIs offer developers the flexibility and control they need to bring their projects to life.

The available APIs for Unica Series amplifiers are:

- Basic protocol
- Advanced protocol
- SNMP protocol

The basic protocol is a simple, human-readable UDP protocol, which allows the user to control and monitor the most commonly used amplifier parameters. The advanced protocol is a more comprehensive HTTP protocol, which allows users to control and monitor nearly all aspects of the amplifier, including DSP settings, AoIP input patch and output settings, Standby and Eco mode settings, GPIO settings, and more. The Unica series amplifiers are also compatible with SNMP protocol, allowing for monitoring from a remote location.

Powersoft not only provides APIs, but also builds and maintains ready-to-use plugins for the most popular third-party system processors. For additional information on the third-party plugins or for the API control protocols for Unica Series amplifiers, please consult the technical documentation available on Powersoft's website or contact the Powersoft support team for further assistance.

Cloud Monitoring

The **Unica Series** amplifiers can be connected to Powersoft's cloud monitoring platform to provide users with remote access to their amplifiers and the ability to monitor their devices in real-time. Additionally, users can configure notifications to be sent via email when certain events occur.

To connect the amplifier to the **Powersoft Cloud**, users must first create an ArmoníaPlus project and add the amplifier to their workspace. Then, they must connect the amplifier to their local network and configure the project for cloud monitoring. For more detailed instructions, please refer to the **Powersoft Cloud User Guide** or the **Powersoft website**.

With the amplifier connected to the Powersoft Cloud, users can configure notifications to be sent via email when certain events happen. These events can include changes in the amplifier's power state, alarms, output channel status, and other information such as model, serial number, and firmware version. Through these notifications, users can easily keep an eye on and troubleshoot their amplifiers from anywhere, making the Powersoft Cloud a powerful tool for system monitoring and maintenance.

OPERATION

Front panel

This chapter provides an overview of the front panel of the amplifier, including its navigation elements, features, and status indicators. It also covers alarms, warnings, and statuses that may appear on the device, and the action that needs to be taken.

Pages

Home



Fig. 1.1 - Home page

Figure 1.1 represents the default state of the Home page.

Amplifier Name (1) is the name of the device set in ArmoníaPlus; the device model name is the default option.

(2) The Device Status block shows the overall state of the device (more details about device statuses can be found in Chapter 2).

(3) The Control Network IP block shows the IP address used for communication with ArmoníaPlus or 3rd Party protocols.

(4) The Power block shows the state of the mains and PoE.

(L1) The Status LED has the following operational behaviour: Amplifier On (steady green), Standby (steady blue), Alarm state (blinking red), Warning state (blinking yellow), All Outputs Muted Mode (blinking cyan), Call Operations (blinking white).

(L2) The Network LED has the following operational behaviour: Ethernet Up and Operational (steady green), Connected to remote control (steady blue), Call Operations (blinking white).

(L3) The Signal LED has the following operational behaviour: Analog Signal Presence (steady green), Dante Input Signal Presence (steady blue), Analog & Dante Input Presence (steady cyan), Limiting in One or More Channels (steady yellow), Call Operations (blinking white).

Navigation

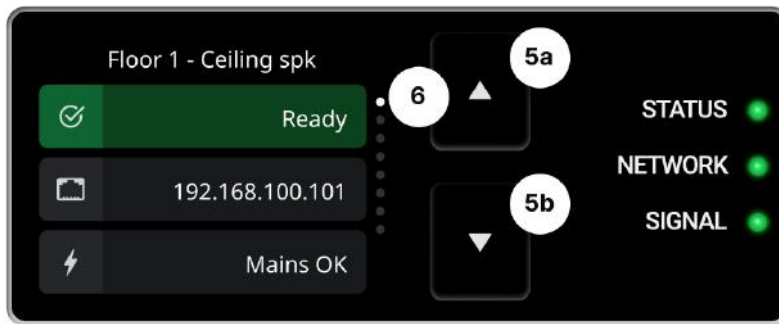

Fig. 1.2 - Navigation

Figure 1.2 shows the navigation elements of the display. Navigation buttons (5a, 5b) allow the user to navigate the pages (6). The last and first pages are continuously linked.

All Outputs Muted Mode

Pressing either the 5a or 5b button for more than 2sec activates the All Outputs Muted status (Fig. 1.3). In this mode, all outputs of the device are muted. To exit this mode, press 5a and 5b simultaneously again; a confirmation dialog will appear (Fig. 1.4). Repeating this action will disengage All Outputs Muted Mode (Fig. 1.5).

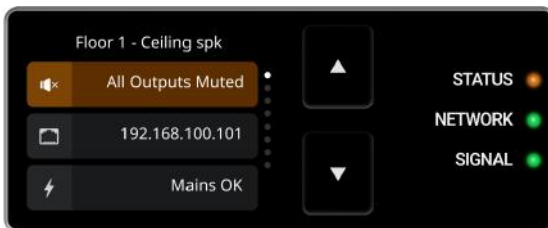

Fig. 1.3 - All Outputs Muted mode engaged

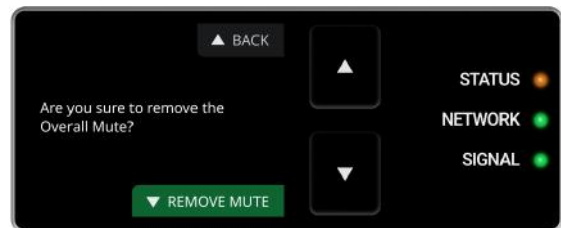

Fig. 1.4 - All Outputs Muted mode exit procedure

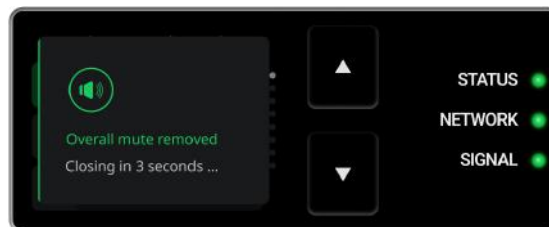

Fig. 1.5 - All Outputs Muted mode disengaged

Headroom

The Headroom page shows the amount of headroom left for each channel (Fig. 1.6).

When limiting is engaged, the bar drops from the top edge in yellow (7a), showing the gain reduction in dB (7b). When one or more channels are muted, the Mute state is engaged. A steady mute icon (8) means that the output is muted, while a blinking mute icon indicates that another type of control is muting the output (e.g. a group).

When two channels are bridged, a connection between the channels is displayed (9).

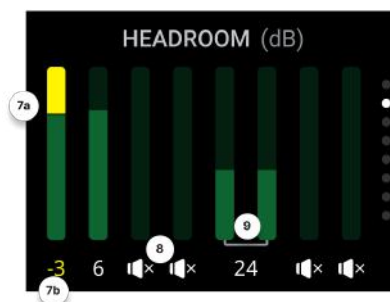

Fig. 1.6 - Headroom page

Speakers

The Speakers page displays speakers in blocks (see Figure 1.7).

A speaker block consists of the output number (10a) and the name assigned to this speaker in ArmoníaPlus (10b). The model name of the speaker preset is the default option.

When a multi-way loudspeaker is present, blocks are represented as in Figure 1.8, where a two-way preset (11) and a three-way preset (12) are shown. Way labels (13) are also displayed in the block.

Multiple-way bridged presets (14) are displayed as in Figure 1.9. A preset can be displayed across multiple pages (15).

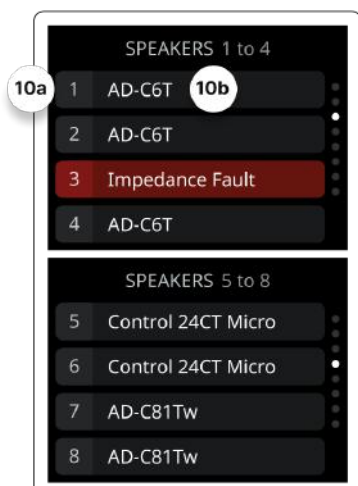

Fig. 1.7 - Speakers page blocks

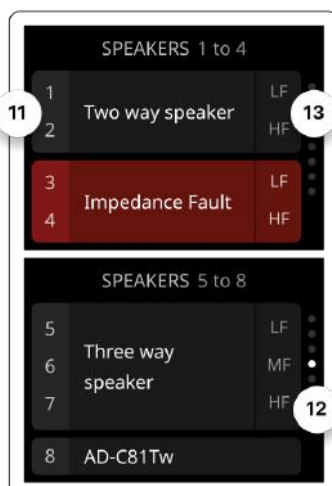

Fig. 1.8 - Multiple Ways presets

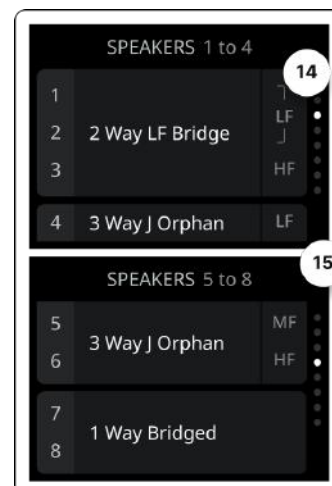

Fig. 1.9 - Multiple Ways bridged preset

Mains & Temperature

The Mains and Temperature page (Fig. 1.10) displays the mains voltage (16) and the current draw (17). A temperature indicator (18a) shows the percentage of the current temperature relative to the high-level threshold. When the temperature rises to the high level (19), the device limits its outputs to avoid an over-temperature state (20).

In this state, the amplifier is muted. High and Over temperature states are indicated as warnings and alarms, respectively, on the Home page (for more details about warning and alarm states, see Section 2). The Temperature History (18b) shows the last hour of the temperature trend.

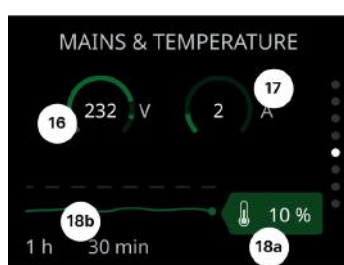

Fig. 1.10 - Mains & Temperature page

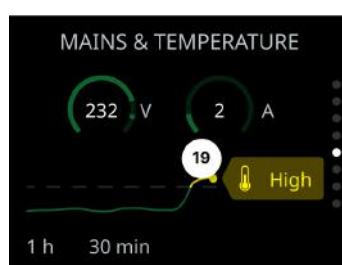

Fig. 1.11 - High temperature state

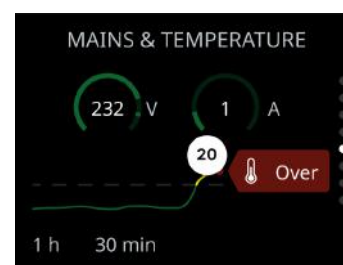

Fig. 1.12 - Over temperature state

Network

The network page consists of two sub-pages: Ports mode (Fig. 1.13a & b) and Ports IP (Fig. 1.14a & b). Each network port is represented by a block (21, 23), composed of the corresponding network protocol (22) and the associated IP address (24).

Fig. 1.13a shows the ports in “Switched mode,” where each port gets the same protocol and the same IP address. Fig. 1.13b shows the “Split redundant” mode, where each port has a different protocol and a different IP address. Fig. 1.14b shows what happens when the network cable is disconnected and the IP address is in static mode (25) or DHCP mode (26).

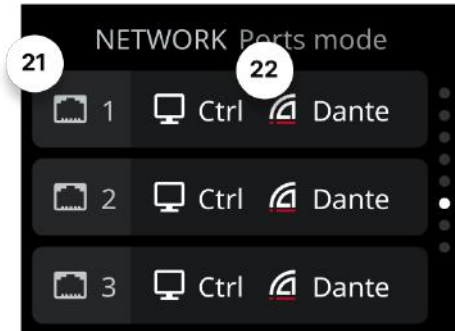

Fig. 1.13a - Ports in Switched Mode

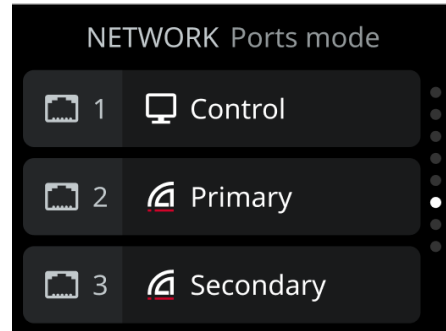

Fig. 1.13b - Ports in Split Redundant Mode

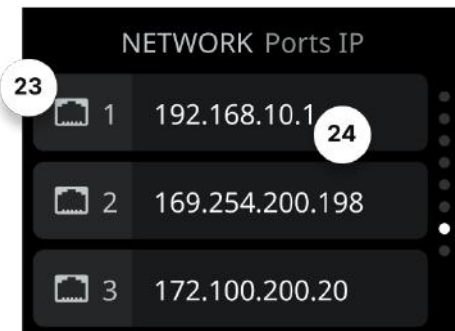

Fig. 1.14a - Ports IP

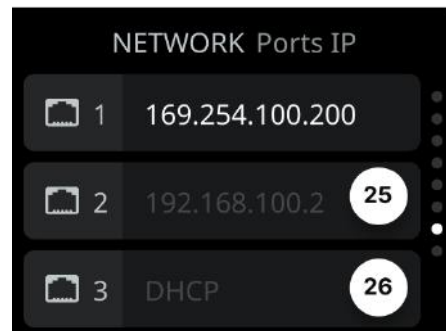

Fig. 1.14b - Cable disconnected

Device Info

Device info is a recap page with Dante name and controller (27), editable in ArmoníaPlus; firmware version (28), serial number (29), and lifetime (30), indicating the cumulative amount of time that the device has been turned on and operational.



Fig. 1.15 - Device Info page

Statuses: Alarms, Warnings and Info

There are three categories of statuses: alarms, warnings, and info. In case two or more statuses of different categories occur simultaneously, priority is given to alarms (high), followed by warnings (mid), and lastly info (low). In case two or more statuses of the same category occur simultaneously, priority is given according to the Priority Level listed.

Alarms

Alarm statuses notify users in case of disruption of the normal amplifier's operation, requiring immediate action. In alarm states, the block and the status LED blink red on and off for one second.

Hardware

Hardware fault (31) consists of any fault or condition that prevents normal amplifier operation and requires immediate attention.



Fig. 2.1 - Hardware fault

Mains

Main fault (32) reports that main voltage is out of range. Figure 2.2 shows an example of Main fault with connected PoE, as the Power block (33) is reporting.

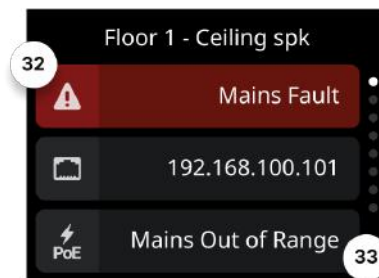

Fig. 2.2 - Mains fault

Over Temperature

In this state, the amplifier is muted due to temperature exceeding operating limits (see Section 1.4 for more details).



Fig. 2.3 - Over Temperature Fault

Hardware Fault on specific Output.

This status (35) is triggered by any output-channel related fault or condition that prevents normal amplifier operation and requires immediate attention. The fault is displayed on the corresponding output block in the Speakers page.

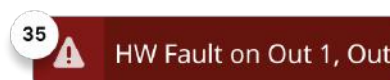

Fig. 2.4 - Hardware fault on specific Output

Load Alarm on specified Output

This fault (36) is shown when any user-configurable output diagnostic tool returns an alarm, or when there is output protection due to a short circuit. X is the number of the output channel. The specific fault (37) is displayed on the corresponding output block in the Speakers page.



Fig. 2.5a - Load Alarm on Out X



Fig. 2.5b - Output faults

No Mains

In this state (38), mains are not connected. Figure 2.6 shows an example of a no mains alarm while the device is powered by PoE.

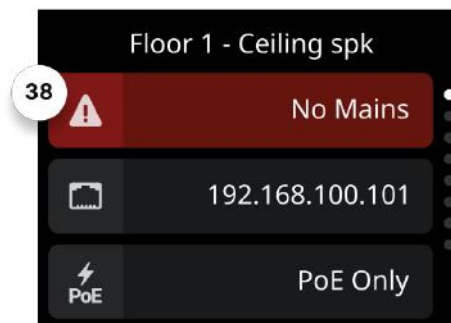

Fig. 2.6 - No Mains

Warnings

Warning states notify the user of the risk of disruption to the normal amplifier's operation (i.e. high temperature) and require attention. In warning states, the block and the status LED blink yellow on and off for one second.

Mains Warning

This warning occurs when the amplifier is operating normally, but there is a risk of triggering over/undervoltage protection. The high or low state of the mains is displayed on the Mains block (39)

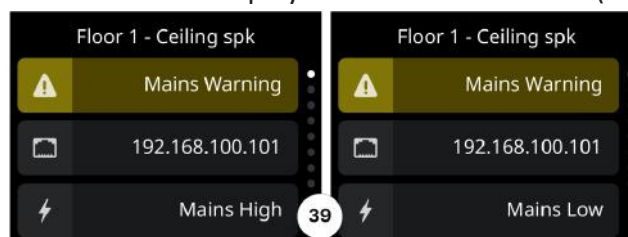

Fig. 2.7 - Mains warning

High Temperature

In this state, the amplifier is limiting its outputs due to high temperature.



Fig. 2.8 - High Temperature warning

All Outputs Muted

When the All Output Muted Mode is engaged, the status block is displayed as in Figure 2.9 (see Section 1.1.2 for more details on how to engage this mode).



Fig. 2.9 - All Outputs Muted warning

Info

Info Statuses notify the user about minor events that are not causing alterations in audio performance.

Cloud Offline

In this state (40), cloud connectivity is enabled but not established. When connectivity is restored, the cloud status icon changes to enabled (41).



Fig. 2.10 - Cloud Offline

Powersoft Cloud

Unica Series amplifiers can connect to the Powersoft Cloud for remote monitoring and control. In the Powersoft Cloud, amplifiers are grouped by Site, that is an ArmoníaPlus project that has been configured to be monitored on the cloud platform.

The Powersoft Cloud is structured as follows:

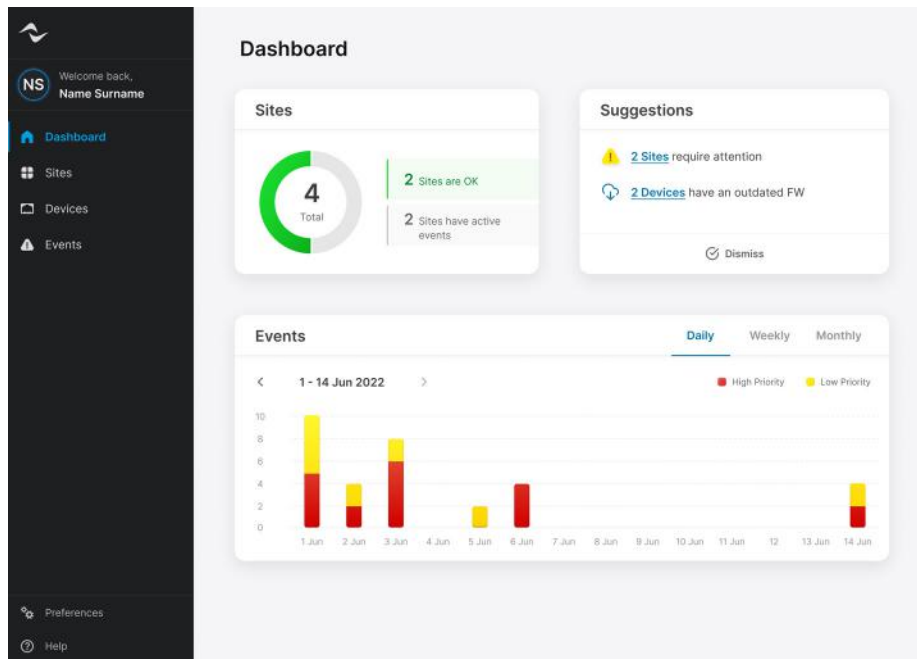

Fig. 3.1 - Dashboard page

The homepage of the platform is the Dashboard page. This page allows the user to monitor the overall status of all of its sites and the corresponding devices, as shown in Figure 3.1 (dashboard fig). The dashboard data visualization is structured in three widgets:

- **Sites**, where a pie chart indicates the status of the managed sites. When active events are ongoing, both the chart and the relative caption are links to the filtered Sites page.
- **Suggestions**, where main tips are presented to the user, in particular sites with ongoing events and devices with outdated firmware.
- **Events chart**, where all the events related to the managed sites are displayed. Chart data can be filtered by priority, date, and ongoing activity. Events visualization can be sorted by daily, weekly, or monthly view.

The **Sites Page** collects all of the sites managed by the user, allowing them to organize them into groups. Groups can be renamed and deleted using their contextual menu; deleting a group moves its Sites to an “Ungrouped” section. Sites can be filtered by name, status, or location. The page view can be sorted alphabetically, both ascending and descending. Additionally, Sites can be renamed, moved to another group (which includes the creation of a new group), shared with another user, or hidden. When a Site is hidden, alarms and notifications regarding it are ceased and will only be restored when the Site is unhidden. The “Move to Group” and “Hide” features are also available via multi-selection.

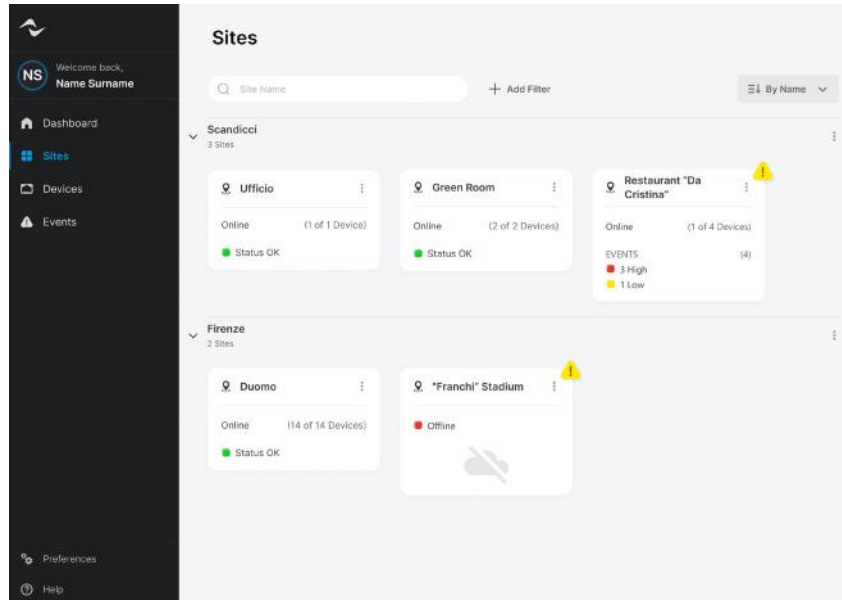

Fig. 3.2 - Sites page

The **Devices page** on the Powersoft Cloud is designed to collect and organize information about all the devices managed by the user. The listing can be filtered by name, by status, by device model, and by the outdated status of the firmware.

Multiple filters can be concatenated to refine the search. Moreover, the table can be sorted by status, name, model, site, and firmware version.

For each device, a contextual menu is provided with two selectable options: “Device info” and “Update firmware”. The “Update firmware” option will only be available when the firmware is outdated. Selecting the “Device info” option will display the signal path of the device, visually representing connections between inputs and speakers.

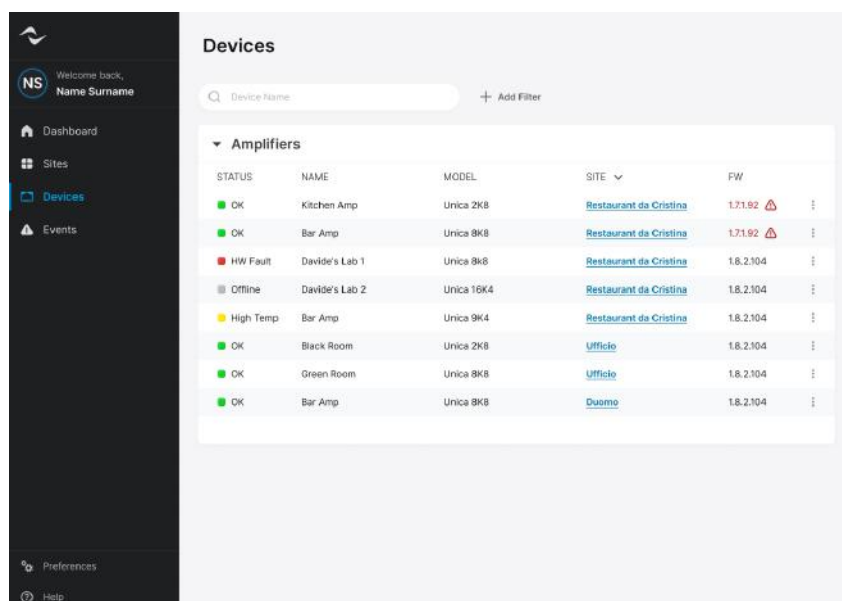

Fig. 3.3 - Devices page

The **Events page** collects and displays all events that have occurred and are ongoing in all managed sites. As shown in Figure 3.4, active events are displayed on top of the listing table, followed by events history. The bar graph can be filtered by event priority, date, and ongoing activity, while the events visualization can be set to daily, weekly, or monthly. In the bottom right corner of the widget is a toggle switch, which provides the user with the ability to turn the visualization of only active events on or off.

The table provides information such as the date the event was triggered, the priority of the event, a link to the corresponding site, and a description of the event. The description includes the name of the device that triggered the event, which is a link to the device section in the specific site page, as well as a brief description of the event.

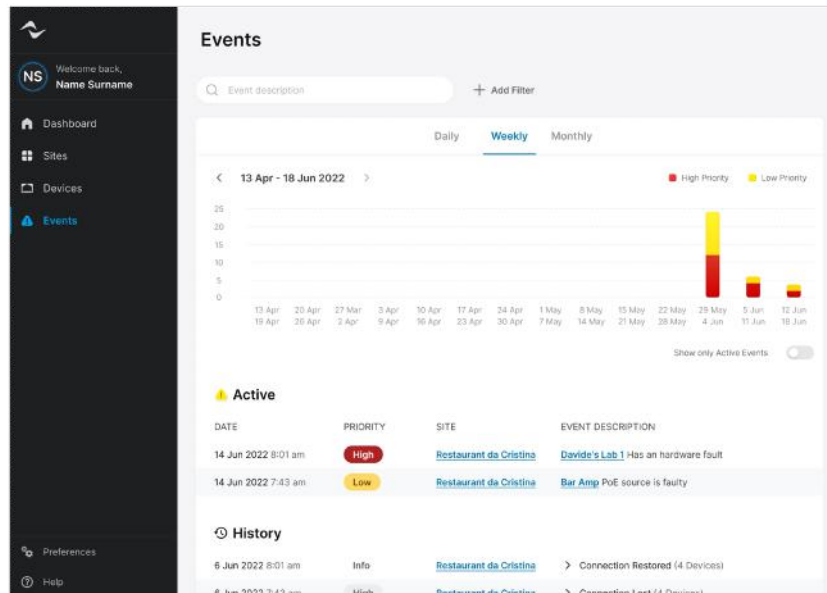

Fig. 3.4 - Events page

The **Site page** collects and shows data of a specific site, each site data can be explored in detail on its individual page (see Figure 3.5). Events are displayed graphically, and users can also access the event history and clear it.

The Device section, accessible via a tab, displays all the devices associated with the specific site. Here, users can perform the same operations as described in Section 3.

The Preferences section provides a link to Account settings, which allows users to set their notification priority and select a theme (dark, light, or inherited from the system).

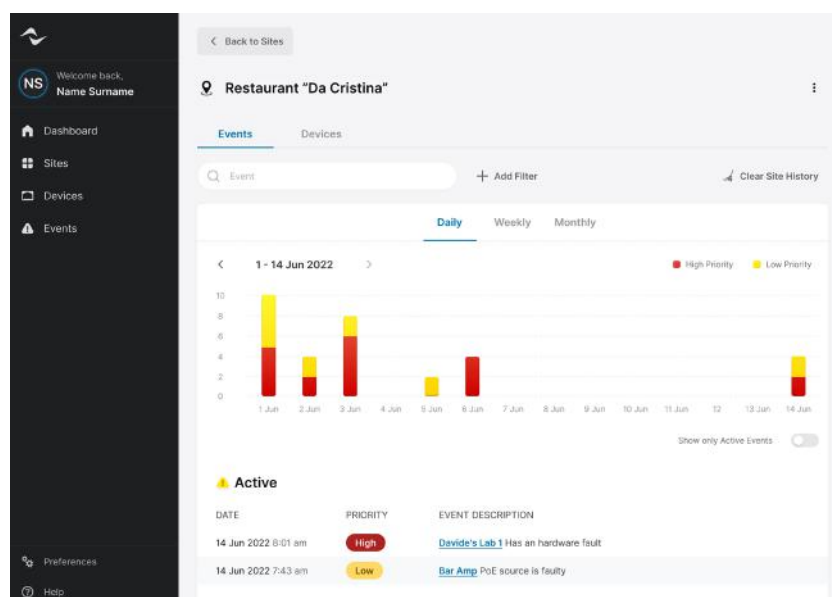

Fig. 3.5 - Site page

MAINTENANCE

Easy Swap

Replacing a faulty amplifier with a new one is made easy with Easy Swap.

To complete the process, the first step is to locate the faulty unit and disconnect all cables from its rear panel. Then, the faulty amplifier is removed from the rack, and the USB drive is kept and inserted into the replacement amplifier. Following the onscreen instructions, the settings of the faulty unit will be loaded onto the replacement amplifier. When the "Restore completed" screen is shown, the input, output, and network cables can be connected and the result tested.

The procedure for replacing a faulty amplifier with a new one is simple and requires just a few steps, as detailed below:

1. **Locate** the faulty amplifier and disconnect all cables from its rear panel.
2. **Remove** the faulty amplifier from the rack.
3. **Keep hold** of the **USB drive** installed on the faulty amplifier.
4. **Install** the replacement amplifier, connecting only the mains cable.
5. **Insert the USB drive** from the faulty unit (step 3) into the replacement amplifier.
6. **Follow** the instructions on the **front display** to load the settings onto the replacement amplifier.
7. **Wait** until the procedure is completed and the "**Restore completed**" screen is shown.
8. **Connect** the input, output, and network cables to the replacement amplifier.
9. **Test the result.**

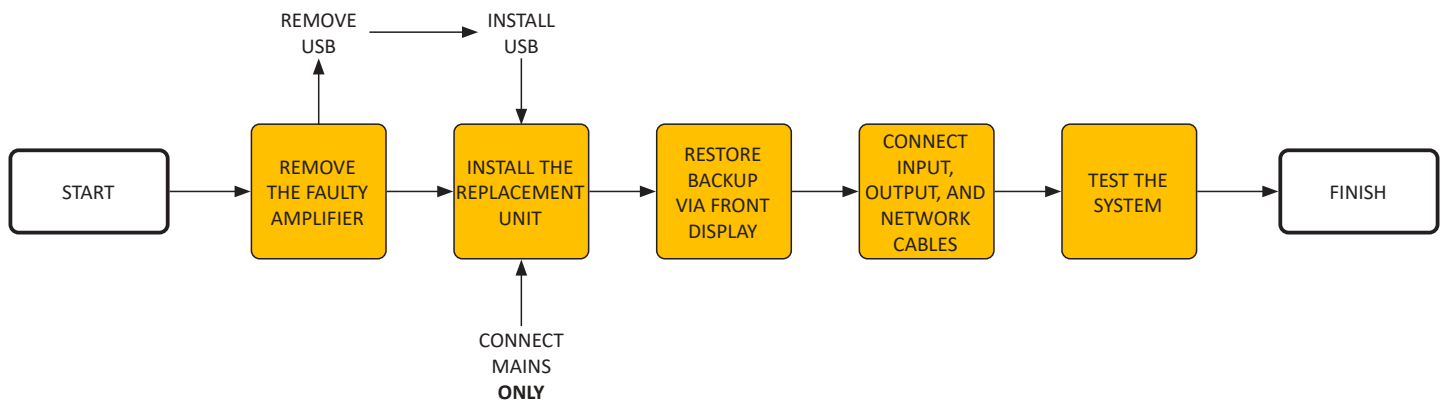

Easy Swap procedure flowchart

Cleaning

When cleaning the amplifier, it is important to use a dry cloth for the chassis and front panel. Air filter cleaning should be scheduled according to the dust levels present in the environment. To clean the vent filters, first remove the front cover. Do not attempt to open any other part of the unit. Compressed air can be used to remove dust from the filters, or they may be washed with clean water. Allow the filter to dry before reassembling.

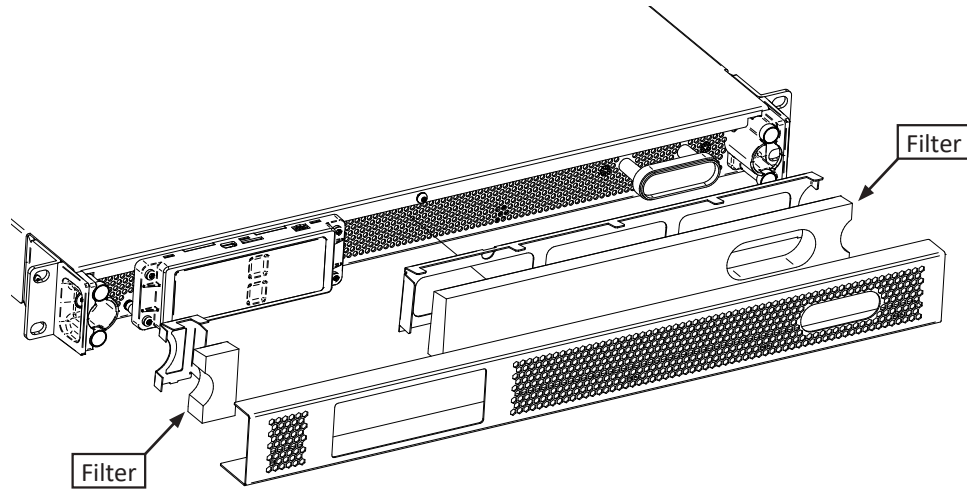

Unica front cover assembly

Updating firmware

Update via ArmoníaPlus software

To update the firmware of two or more amplifiers, open the System List (1) and select the outdated amplifiers (2). Then, click on "Update" (3) and the firmware will be updated.

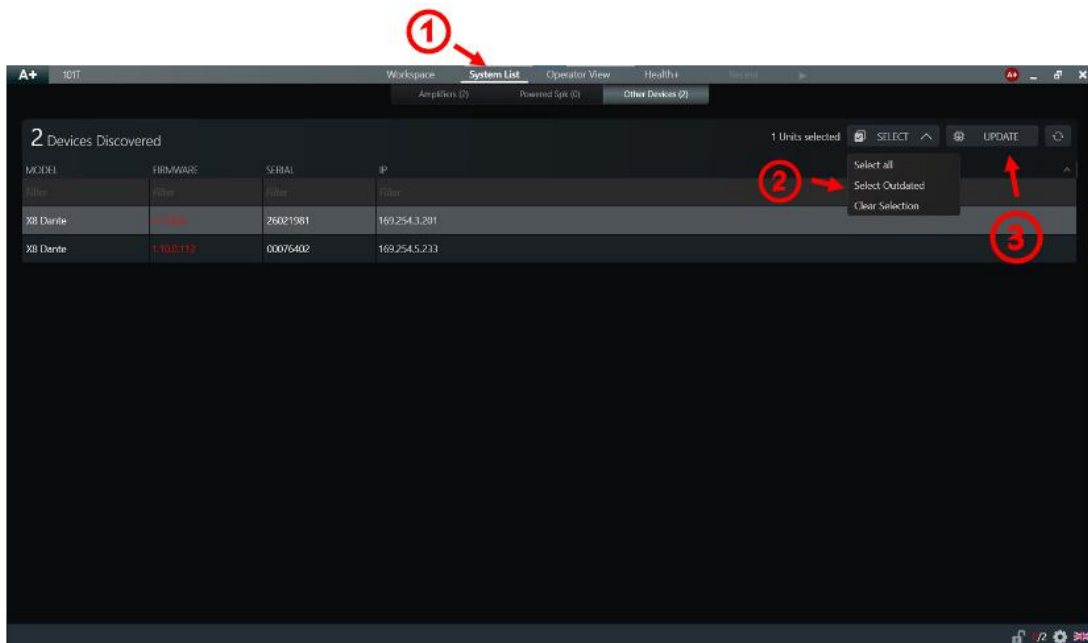

Unica FW update via ArmoníaPlus

Update via Powersoft Cloud

Updating the firmware of amplifiers is possible via the cloud. When one or more amplifiers have outdated firmware, a suggestion will appear in the suggestion box (1) with a link to update it.

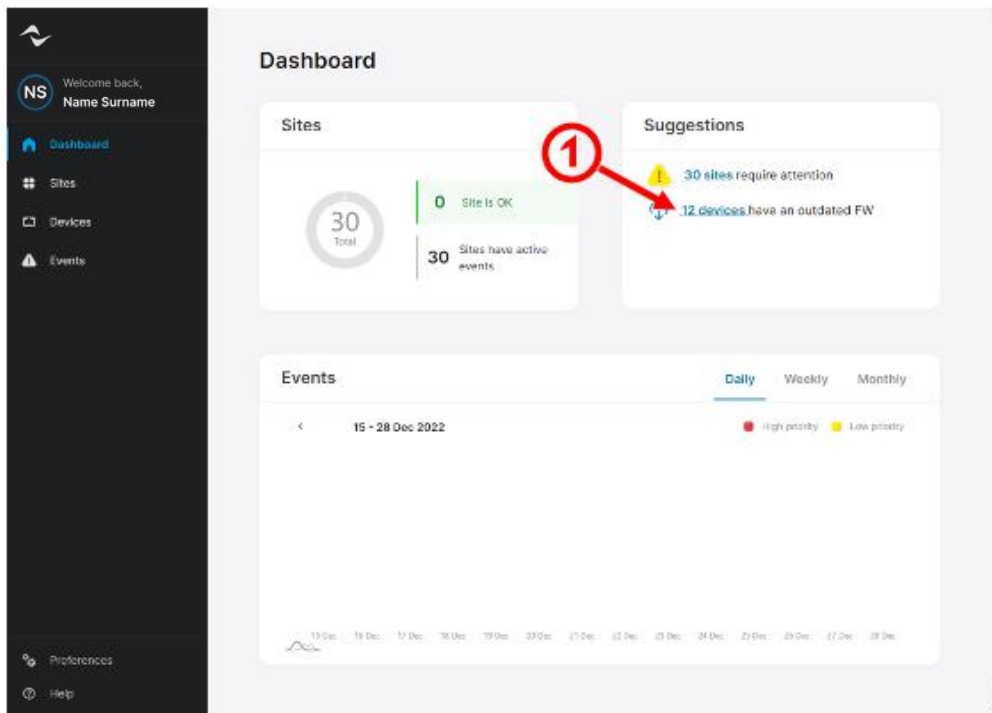

Unica FW update via Cloud - Outdated FW Notification

To update outdated amplifiers in the system, select the desired amplifiers from their check box and then click the Update button. The link in the devices panel will take you to the page where you can apply a filter to view all the outdated amplifiers.

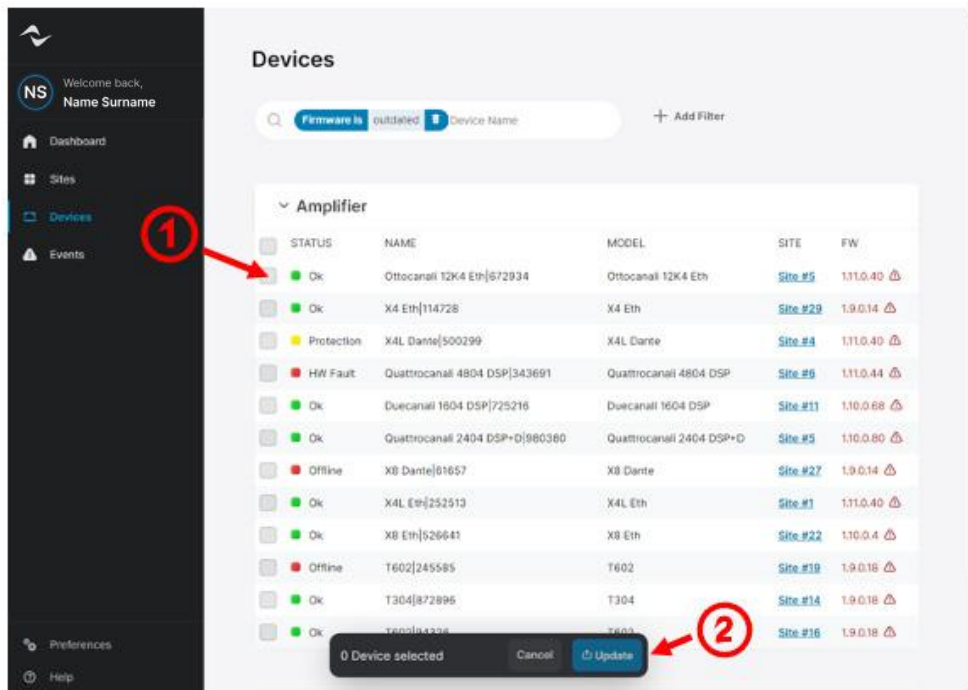

Unica FW update via Cloud - Selecting amplifiers and updating FW

APPENDIX

Network Security

The Unica series amplifiers feature an advanced level of network security to help users comply with stringent installation requirements against external cyber attacks or accidental tampering of the amplifier configuration. The network security webpage provides multiple features to minimize the point of access to the device and prevent unauthorized control.

Users can turn specific protocols on and off to restrict access to the amplifier, ensuring that only necessary data is transmitted. They can also implement an authentication mechanism with custom credentials to prevent others from controlling the amplifier via the Advanced API protocol and third-party plugins, such as Q-SYS. Additionally, the webpage allows for the protection of itself with custom credentials, similar to a network switch.

To access the network security webpage, please visit <https://AmplifierIP/security>, where “AmplifierIP” is the IP address of the Control Port of the amplifier. The default credentials for accessing the Network Security page are:

Username: admin

Password: admin

We recommend changing these default credentials to add an extra layer of security and prevent tampering with the settings. Our network security measures provide peace of mind, allowing you to focus on your sound system performance.

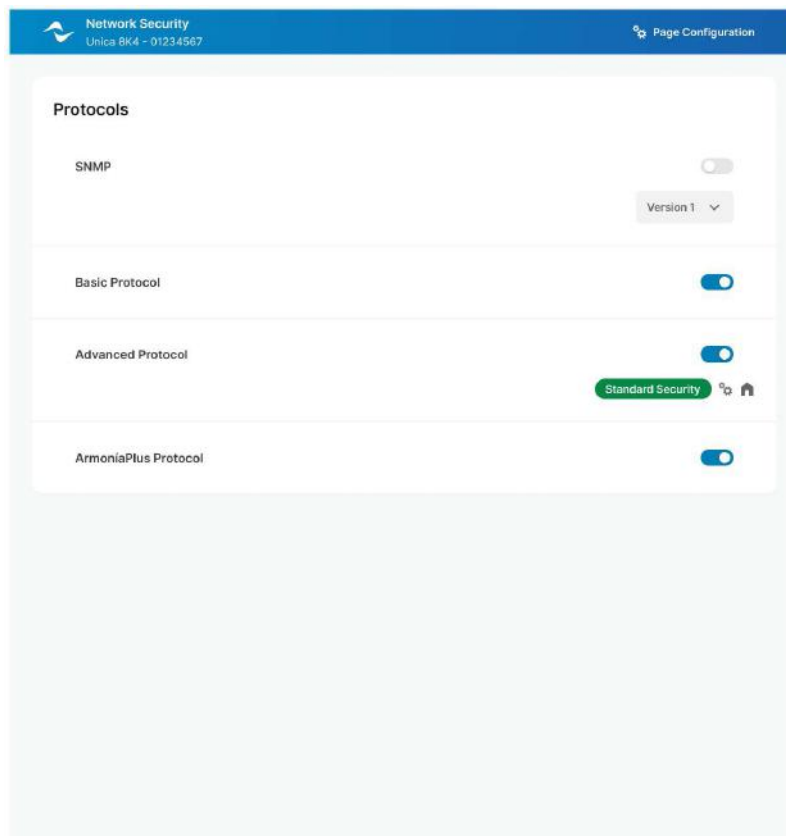

Unica Network Security - Configuration webpage

PoE Features

The Unica series amplifiers from Powersoft feature a dedicated Power over Ethernet (PoE) input on the rear panel, allowing for different applications depending on the amount of PoE power delivered to the amplifier. Class 4 or higher Power Supply Equipment (PSE) can be connected to support both PoE+ and PoE++, and the available functionality of the amplifier varies according to the available power:

- PoE+

When Unica is powered via PoE+, then it is possible to control and configure the amplifier via the Ethernet network, including Dante routing and settings, but the amplifier channels are turned off and it is not possible to drive loudspeakers.

- PoE++

When the PSE is PoE++ and the amplifier is powered with at least 71.3W, then it is possible to control and configure the amplifier as when powered via PoE+, while also monitoring the loudspeaker status via the onboard pilot tone generator and load monitor.

The table below highlights the available functionalities in detail:

Scenario	Available functionality	PoE (802.3af)	PoE+ (802.3at)	PoE++ (802.3bt, Class 5-7)	PoE++ (802.3bt, Class 8)
PoE backup power	Network Connectivity Dante/AES67 Connectivity DSP Configuration	NO	YES	YES	YES
PoE-only System Setup and Test/Monitoring	Network Connectivity Dante/AES67 Connectivity DSP Configuration Power Output Diagnostics Loudspeaker Diagnostics	NO	NO	NO	YES(*)

(*) Up to 8W total output power is available when powered through PoE++ (Class 8, 90W PSE).

For more details check the [white paper](#) on our website.

Third-Party Plugins

Third-party plugins are available for the Unica series amplifiers, to easily integrate Unica in larger systems with third-party processors.

Q-SYS

The Unica series amplifiers can be integrated into a Q-SYS system, allowing for remote control and monitoring. The Q-SYS plug-in is developed and maintained by Powersoft.

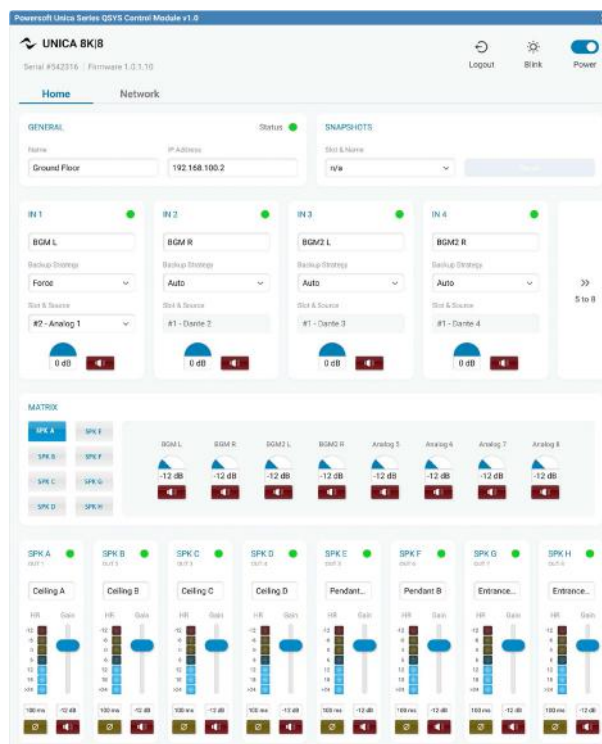

Q-SYS plugin interface for Unica series amplifiers

Crestron

The Unica series amplifiers can be integrated into a Crestron System, allowing for remote control and monitoring. The Crestron plug-in is developed and maintained by Powersoft.

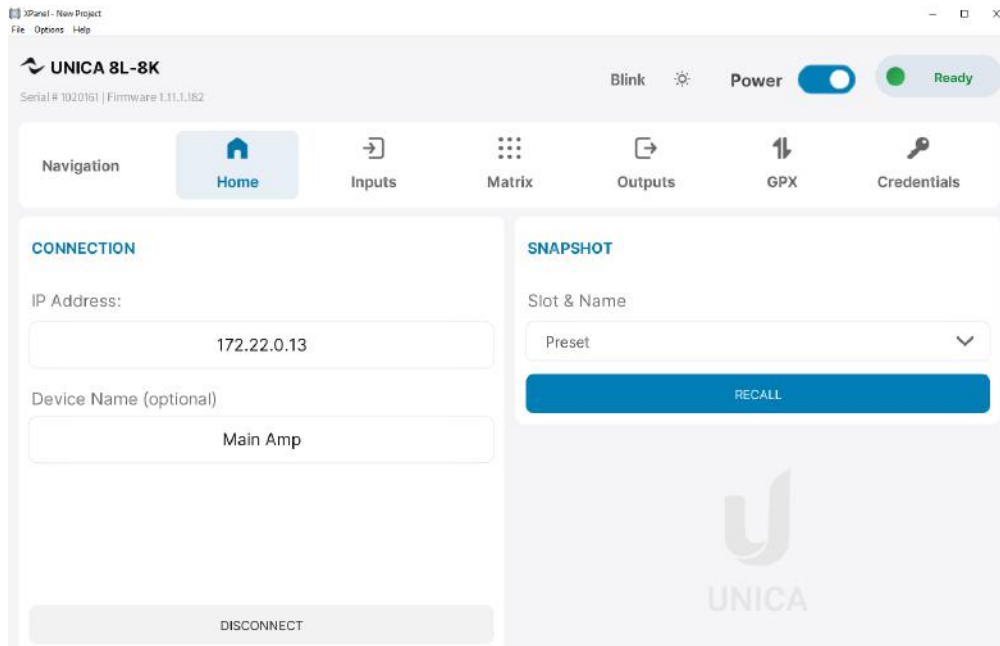

Crestron plugin interface for Unica series amplifiers

Symmetrix

The Unica series amplifiers can be integrated into a Symmetrix System, allowing for remote control and monitoring. The Symmetrix plug-in is developed and maintained by Powersoft.

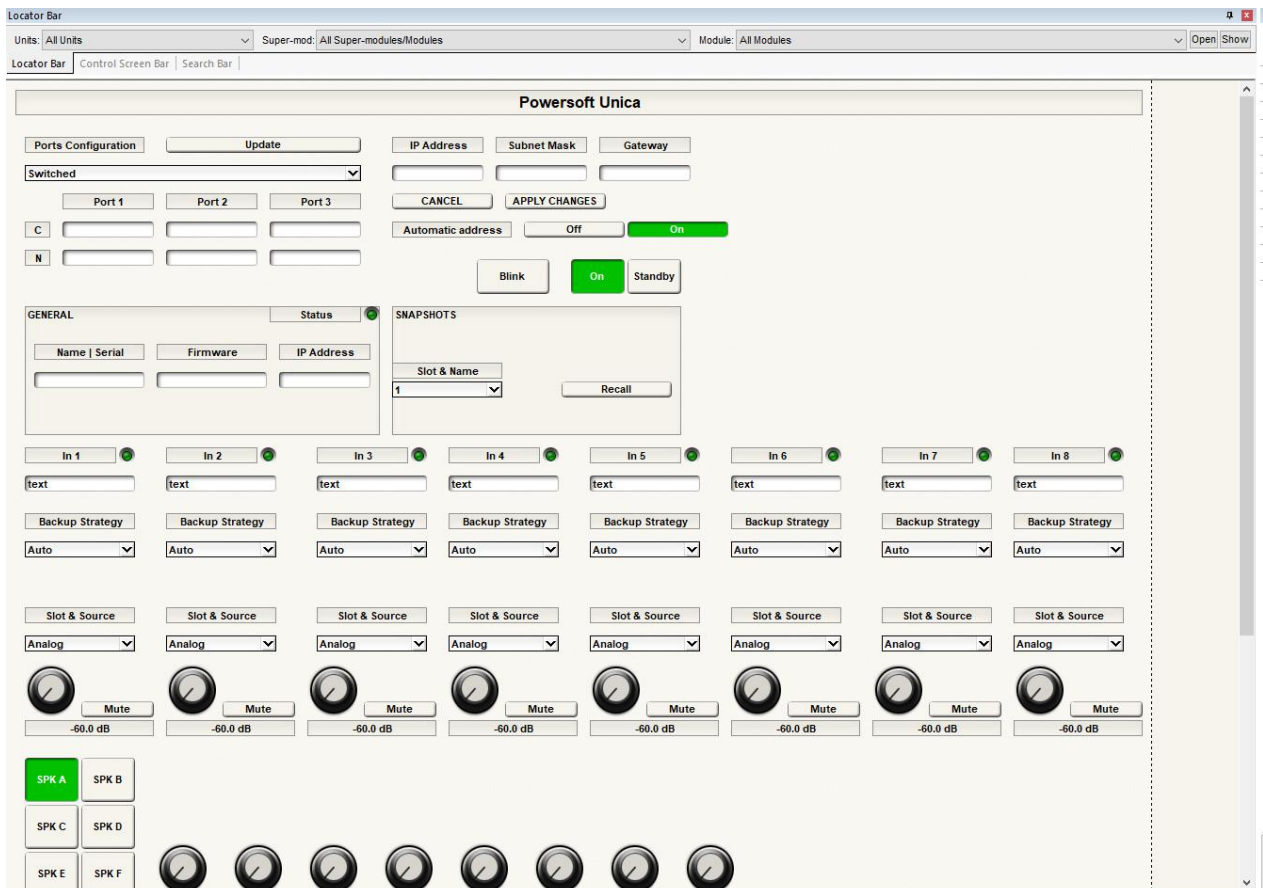

Symmetrix plugin interface for Unica series amplifiers



DRIVING HUMAN AUDIO EXPERIENCE

POWERSOFT S.P.A.
Via E. Conti, 5 - Scandicci (FI) 50018 - Italy
support@powersoft.com
+39 055 73 50 230
+39 055 73 56 235

[POWERSOFT.COM](https://www.powersoft.com)