



D i s t r i b u t i o n A G

SCT-SWKVM411-H2U3

HDMI2.0 KVM Switcher



User Manual

All Rights Reserved

Version: SCT-SWKVM411-H2U3_2023 V1.0.0

Preface

Read this user manual carefully before using the product. Pictures shown in this manual is for reference only. Different models and specifications are subject to real product.

This manual is only for operation instruction, please contact the local distributor for maintenance assistance. The functions described in this version were updated till June, 2022. In the constant effort to improve the product, we reserve the right to make functions or parameters changes without notice or obligation. Please refer to the dealers for the latest details.



SAFETY PRECAUTIONS

To ensure the best from the product, please read all instructions carefully before using the device. Save this manual for further reference.

- Unpack the equipment carefully and save the original box and packing material for possible future shipment.
- Follow basic safety precautions to reduce the risk of fire, electrical shock and injury to persons.
- Do not dismantle the housing or modify the module. It may result in electrical shock or burn.
- Using supplies or parts not meeting the products' specifications may cause damage, deterioration or malfunction.
- Refer all servicing to qualified service personnel.
- To prevent fire or shock hazard, do not expose the unit to rain, moisture or install this product near water.
- Do not put any heavy items on the extension cable in case of extrusion.
- Do not remove the housing of the device as opening or removing housing may expose you to dangerous voltage or other hazards.
- Install the device in a place with fine ventilation to avoid damage caused by overheating.
- Keep the module away from liquids.
- Spillage into the housing may result in fire, electrical shock, or equipment damage. If an object or liquid falls or spills on to the housing, unplug the module immediately.
- Do not twist or pull by force ends of the cable. It can cause malfunction.
- Do not use liquid or aerosol cleaners to clean this unit. Always unplug the power to the device before cleaning.
- Unplug the power cord when left unused for a long period of time.
- Information on disposal for scrapped devices: do not burn or mix with general household waste, please treat them as normal electrical wastes.

Table of Contents

- 1. Introduction 2
 - 1.1. Overview 2
 - 1.2. Features 2
 - 1.3. Package Contents 3
 - 1.4. Specifications 4
 - 1.5. Panel Descriptions 7
 - 1.5.1. Front Panel 7
 - 1.5.2. Rear Panel 7
- 2. Installation and Wiring 9
 - 2.1. Installation 9
 - 2.2. Wiring 9
- 3. IR Remote Control 12
- 4. Serial Port Operation 13
 - 4.1. RS232 Control 13
 - 4.2. Serial Port Routing 13
- 5. Web UI Control 15
 - 5.1. Get Access to the Web UI 15
 - 5.2. Web UI Introduction 15
 - 5.2.1. Switcher Control 15
 - 5.2.2. General Setting 17
 - 5.2.3. Advanced Setting 19
- 6. Customer Service 25
 - 6.1. Warranty 25
 - 6.2. Scope 25
 - 6.3. Warranty Exclusion: 25
 - 6.4. Documentation: 25

1. Introduction

1.1. Overview

This product is a 4x1 HDMI2.0 KVM switcher that supports full 4K and USB 3.0/2.0 switching between four HDMI inputs and one group of HDBT and HDMI outputs. It can transmit 4K@60Hz signals up to 100m/330ft via a single Cat 6a/7 cable. It features not only basic functions like HDMI and USB switching and control (IR, RS232, LAN), but also advanced functions like auto-downscaling for HDMI and HDBT outputs when 1080P display is connected. With four USB host ports switching, the product also supports multiple USB devices that include two local USB3.0 devices and more remote USB2.0 devices via HDBaseT link for flexible installations.

1.2. Features

- 4x1 KVM switcher with HDMI 2.0 and USB 3.0 switching.
- 4x1+1 video switcher, with 4x HDMI 2.0 inputs and 1x HDBT 3.0 + 1x HDMI 2.0 (mirror) outputs.
- 4x1 USB 3.0 switcher, with 4x USB3.0 Host devices, which can be switched to multiple USB devices, which includes 2x local USB 3.0 devices and more remote USB 2.0 devices via HDBT link.
- HDMI and USB can be switched simultaneously (default) or independently.
- HDCP 2.2 and backward compliant.
- Transmits 4K@60Hz signals up to 100m/330ft via a single Cat 6a/7 cable.
- Simple 4K-to-1080P downscalers built-in HDBT and HDMI outputs.
- One-way IR control from the switcher to the connected HDBT receiver at output zone.
- One-way PoE function enables the switcher to supply power for the connected HDBT receiver.
- Support audio de-embedded from HDBT/HDMI outputs.

HDMI2.0 KVM Switcher

- Multiple control options, including front panel buttons, IR, RS232 and LAN (Telnet/Web UI).

1.3. Package Contents

- 1 x SCT-SWKVM411-H2U3 Switcher
- 1 x AC Power Cord (with EU Pins)
- 2 x Phoenix Male Connectors (3.5mm, 3 Pins)
- 2 x Mounting Brackets (with Screws)
- 1 x User Manual

1.4. Specifications

Technical	
Input/Output Port	4 x HDMI IN, 1 x HDMI OUT, 1 x HDBT OUT, 4 x USB HOST, 2 x USB DEVICE, 1 x AUDIO OUT, 1 x RS232, 1 x LAN, 1 x IR IN, 1 x AC 100-240V 50Hz/60Hz POWER IN
Input Video Signal	HDMI with 4K@60 YUV 4:4:4, HDCP 2.2
Output Video Signal	HDBT, HDMI
Input/Output Resolutions	4096 x 2160 ^{2,5,6,7,8} (YUV 4:4:4), 3840 x 2160 ^{2,5,8} (YUV 4:4:4), 2560x1600 ⁸ , 2560x1440 ⁸ , 1920x1200 ⁸ , 1920x1080P ⁸ , 1680x1050 ⁸ , 1600x1200 ⁸ , 1600x900 ⁸ , 1440x900 ⁸ , 1366x768 ⁸ , 1360x768 ⁸ , 1280x1024 ⁸ , 1280x960 ⁸ , 1280x800 ⁸ , 1280x768 ⁸ , 1280x720 ⁸ , 1024x768 ⁸ , 800x600 ⁸ 1 = at 23.98 Hz, 2 = at 24 Hz, 3 = at 25 Hz, 4 = at 29.97 Hz, 5 = at 30 Hz, 6 = at 50 Hz, 7 = at 59.94 Hz, 8 = at 60 Hz
Audio Format	<ul style="list-style-type: none"> HDMI In/Out: Fully supports audio formats in HDMI 2.0 specification, including PCM 2.0/5.1/7.1, Dolby TrueHD, Dolby Atmos, DTS-HD Master Audio and DTS:X HDBT: Same as HDMI Out AUDIO OUT: Stereo only
Maximum Pixel Clock	600MHz
Maximum Data Rate	18Gbps
USB	4 x USB 3.0 host port (type-B, up to 5Gbps) 2 x USB 3.0 device ports (type-A, up to 5Gbps, each port can supply a max current of 1A) 1 x HDBT USB extensions (USB 2.0, up to 300Mbps)
Control Method	RS232, Front Panel Button, LAN (Web UI/Telnet)
General	
Operating Temperature	0°C to 45°C (32°F to 113°F)
Storage Temperature	-20°C to 70°C (-4°F to 158°F)
Humidity	10% to 90%, non-condensing
ESD Protection	Human-body Model: ±8kV (Air-gap discharge)/ ±4kV (Contact discharge)
Power Supply	AC 100-240V 50/60Hz
Power Consumption (Max)	49.2W
Device Dimension (W x H x D)	440mm x 43.5mm x 225mm/17.32" x 1.71" x 8.86"
Product Net Weight	0.85kg/1.87lbs

HDMI2.0 KVM Switcher Transmission Distance

Note:

- Straight-through category cable wired to T568B standard is recommended.
- For max HDMI 2.0 resolution recommended cable is: Cat 6a U/FTP or F/FTP.

Cable Type	Range	Supported Video
Cat 5e/6	70m/230ft	1080P@60Hz 4K@30Hz 4K@60Hz 4:2:0 36bpp
	40m/131ft	4K@60Hz 4:4:4 24bpp 4K@60Hz 4:2:2 36bpp
Cat 6a (U/FTP)	100m/330ft	1080P@60Hz 4K@30Hz 4K@60Hz
Cat 7	100m/330ft	1080P@60Hz 4K@30Hz 4K@60Hz

Use Patches

Note:

Patches may be used in the installation, and the patches will obviously affect the transmission distance. Limits and distances are as follows:

- Support up to 2 patch cables, each not exceeding 5m.
- Patches must be installed on both ends of the device, refer to the following pictures:

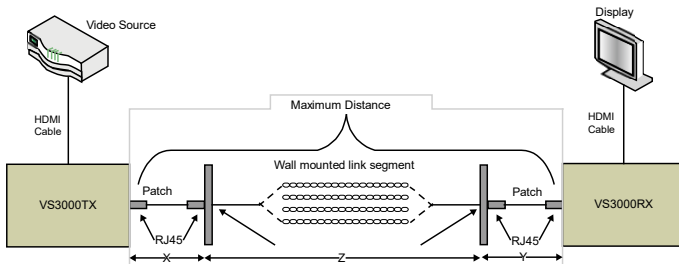

The standard specifies the following lengths for the three-segment cable installation:

HDMI2.0 KVM Switcher

- X = Left-side patch cable length \leq 5 [meter]
- Y = Right-side patch cable length \leq 5 [meter]
- Z = Wall segment \leq Maximum Distance – X – Y [meter]

Cable Type	Range	Supported Video
Cat 5e/6	70m/230ft (with Patches)	1080P@60Hz 4K@30Hz 4K@60Hz 4:2:0 36bpp
	30m/100ft (with Patches)	4K@60Hz 4:4:4 24bpp 4K@60Hz 4:2:2 36bpp
Cat 6a (U/FTP)	70m/230ft (with Patches)	4K@60Hz 4:4:4 24bpp 4K@60Hz 4:2:2 36bpp
	100m/330ft (with Patches)	1080P@60Hz 4K@30Hz 4K@60Hz 4:2:0 36bpp
Cat 7	100m/330ft (with Patches)	1080P@60Hz 4K@30Hz 4K@60Hz 4:2:0 36bpp

1.5. Panel Descriptions

1.5.1. Front Panel

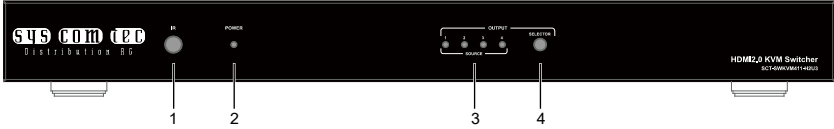

ID	Name	Description
1	IR window	Receive IR signals.
2	POWER LED	<ul style="list-style-type: none"> On: The device is powered on. Off: The device is powered off.
3	SOURCE LED (1-4)	<ul style="list-style-type: none"> On: HDMI IN (1-4) is selected. Off: HDMI IN (1-4) is not selected.
4	SELECTOR Button	Click to select input source for HDBT OUT / HDMI OUT.

1.5.2. Rear Panel

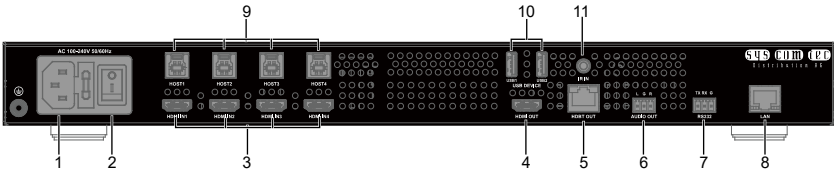

ID	Name	Description
1	AC 100-240V 50Hz/60Hz	Connect to the power adapter provided.
2	Power Button	Press to turn on/off the device.
3	HDMI IN (1-4)	Connect to HDMI sources.
4	HDMI OUT	Connect to an HDMI display
5	HDBT OUT	Connect to an HDBT receiver. (Such as SCT-HDBT3KVM-TRX)
6	AUDIO OUT	Connect to an audio receiver for audio de-embedded output.
7	RS232	Connect to a control PC or control system for RS232 serial control.
8	LAN	Connect to a control system for Web UI or Telnet control.
9	USB HOST	Connect to USB host PC.

HDMI2.0 KVM Switcher

ID	Name	Description
	(1-4)	By default, USB Host 1-4 ports are bound with HDMI IN 1-4 respectively, and they also can be set independently through API or Web UI, detail information, please refer to the separate document “ <i>API Command Set SCT-SWKVM411-H2U3</i> ” or “ Web UI Control ” section.
10	USB DEVICE (1&2)	Connect to USB devices such as keyboard & mouse, USB camera.
11	IR IN	Connect to an IR receiver cable.

2. Installation and Wiring

2.1. Installation

Warnings:

- Before wiring, disconnect the power from the device.
- During wiring, connect and disconnect the cables gently.

To install the device to a suitable location, perform the following:

1. Attach the installation bracket to the enclosure using the screws provided.
The bracket is attached to the enclosure as shown.

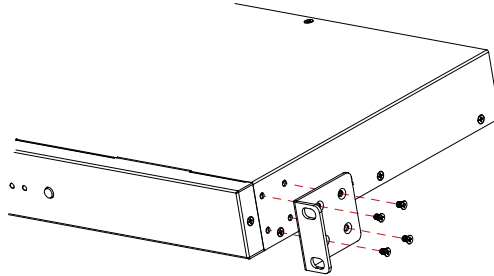

2. Repeat steps 1-2 for the other side of the device.
3. Attach the brackets to the surface you want to hold the device against using the screws (not included).

2.2. Wiring

1. Connect the HDMI sources (such as PC) to the HDMI IN 1-4 ports.
2. Connect an HDMI display device (such as TV, projector, LED/LCD display) to the HDMI OUT port.
3. Connect an HDBT receiver (such as SCT-HDBT3KVM-TRX) to HDBT OUT port, and connect display to the receiver.
4. Connect USB host PCs to USB HOST 1-4 ports of the device, and connect USB devices (such as USB camera, Keyboard & Mouse) to USB 1&2, and

HDMI2.0 KVM Switcher

USB ports of the connected HDBT receiver.

Note:

- a) If the connected HDBT receiver is connected to multiple USB devices or high-power USB devices, users need to connect a separate power supply to the receiver.
 - b) By default, USB control is in follow mode, USB Host 1-4 ports are bound with HDMI IN 1-4 respectively. When select one source from HDMI IN 1-4 for HDMI/HDBT OUT, the USB devices connected to USB DEVICE 1&2 ports and HDBT receiver will be connected to the corresponding USB host bound with the selected source.
 - c) Through API commands and Web UI, USB Control can be set to independent mode and users can set USB devices to be connected to any USB host. For example, select HDMI IN 1 as input source for HDMI/HDBT OUT. Users can connect USB devices connected with USB DEVICE 1&2 and HDBT receiver to any USB HOST such as USB HOST 2. (Detail information, please refer to the separate document “API Command Set_SCT-SWKVM411-H2U3” or “[Web UI Control](#)” section)
5. Connect an audio receiver such as an amplifier) to AUDIO OUT port.
 6. Connect for additional control options:
 - **IR Control:**
 - a) Using the IR remote directly point to the IR window to control the switcher. (Detail information, please refer to “[IR Remote Control](#)” section)
 - b) Connect IR receiver cable to IR IN port of the switcher, connect IR emitter cable to HDBT receiver, then users can use the corresponding display remote to control the display connected with HDBT receiver at switcher side.
 - **RS232 Control:** Connect to a control PC or control system for RS232 serial control.
 - **LAN Control:** Connect LAN port of the switcher to a local network

HDMI2.0 KVM Switcher

with DHCP server, and connect a PC to the same network.

7. Connect to the provided power adapter to the switcher (With one-way PoE function, the switcher can supply power for the connected HDBT receiver).
8. Power on all attached devices.

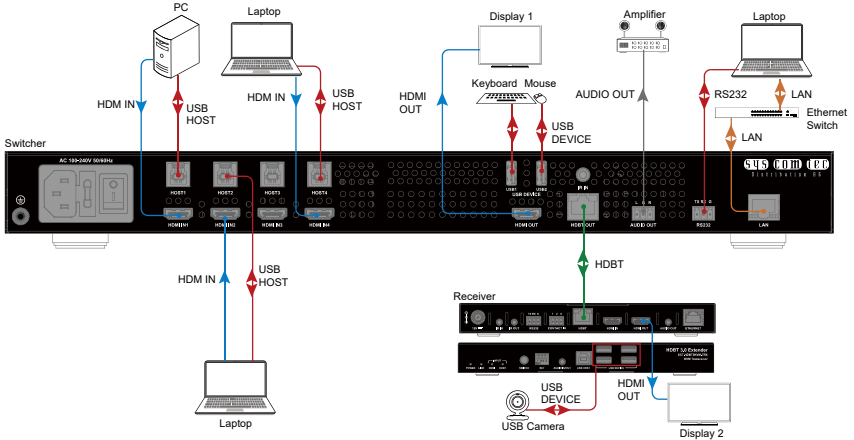

3. IR Remote Control

The remote-control handset can be used to turn on and off a CEC-enabled display and select input source for output.

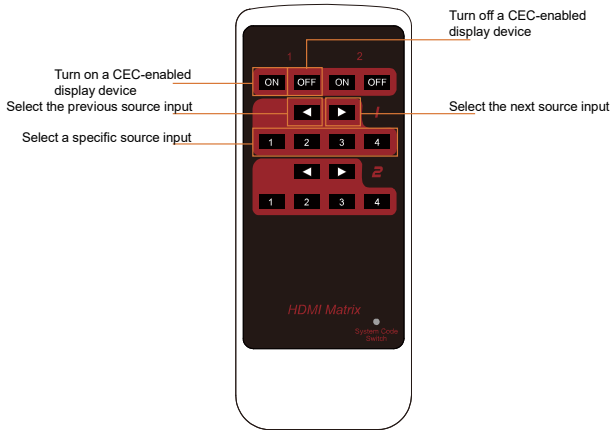

Note:

1. As the internal battery inside the remote control of our device is packaged by insulation slice, please remove the insulation slice before use.
2. Please make sure that the remote is pointed directly at the IR receiver window.
3. Other buttons (2 (ON/OFF) and 2 (1-4)) not marked in above figure can't be used to control the switcher.

System Code Switch

The IR Remote provided with the switcher is shipped in "00" IR system code. In the event that Remote's IR signal interferes with IR devices, e.g., TV, DVD player, the Remote can be switched to "4E" code by short pressing the System Code Switch on the Remote panel. At the same time, you must redefine the IR system code of the switcher using the API command.

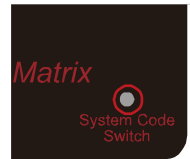

4. Serial Port Operation

4.1. RS232 Control

Advanced users may need to control the switcher through RS232 serial communication. Connect a control PC or control system to the RS232 port of the switcher. API command for RS232 control is available in the separate document “API Command Set_SCT-SWKVM411-H2U3”. A professional RS232 serial interface software (e.g. Serial Assist) may be needed as well.

Before executing the API command through RS232 serial connection, please ensure RS232 interface of the device and the control PC are configured correctly.

Parameters	Value
Baud Rate	115200 bps
Data Bits	8 bits
Parity	None
Stop Bits	1 bit
Flow Control	None

4.2. Serial Command Routing

The switcher supports serial command routing function to HDBaseT receivers from switcher LAN port.

- Users can send commands and receive responses through switcher LAN port to HDBT receiver connected 3rd-party devices.
- Each HDBaseT output has a dedicated TCP/IP port on the switcher.
 - 5001 - serial routing TCP/IP port for HDBaseT output
- API commands are complete transmission, and not need to add extra terminator. For example, when switcher IP is 192.168.0.100, all data that goes to 192.168.0.100 port 5001 will also output from RS-232 port of switcher HDBT output receiver.

HDMI2.0 KVM Switcher

4. When using serial command routing, the default values of serial connection are as follows:

Parameters	Value
Baud Rate	9600 bps
Data Bits	8 bits
Parity	None
Stop Bits	1 bit

Users can use switcher API to change the serial parameters of 5001 port independently according to different connected devices, the command is as follows:

```
SET UART_CFG out prm1 prm2 prm3 prm4<CR><LF>
```

Description:

```
out={5001 | UART1};
```

```
prm1={9600, 19200, 38400, 57600, 115200};
```

```
prm2={none, odd, even};
```

```
prm3={7, 8};
```

```
prm4={1, 2};
```

<CR><LF> denotes a carriage return or a line feed.

Note: when sending the SET UARG_CFG API, it should be sent to switcher TCP/IP port 23.

5. Web UI Control

The Web UI designed for the switcher is available for basic controls and advanced settings of the device. The Web UI can be accessed through a browser with latest version, e.g. Chrome, Firefox, Safari, Opera, IE, etc.

5.1. Get Access to the Web UI

1. Connect the LAN port of the switcher to the local area network, and connect your PC to the same network (The default IP mode is DHCP, please ensure the local area network is connected with a DHCP server).
2. Get IP address through API commands (see the separated document “*API Command Set_SCT-SWKVM411-H2U3*”) or other tools such as SmartSetGUI.
3. Input the IP address obtained in step 2 in your browser and press Enter. The following window will display.

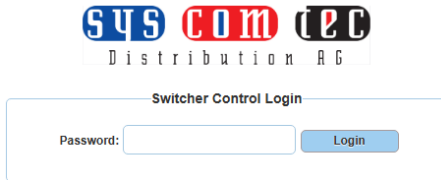

4. Input the login password and click “Login”. The default password is “admin”.

5.2. Web UI Introduction

The main screen includes Switcher Control, General Setting and Advanced Setting.

5.2.1. Switcher Control

There are four submenus in this page: Switcher Control, USB Control, Audio Control and Preset.

HDMI2.0 KVM Switcher

1) Switcher Control

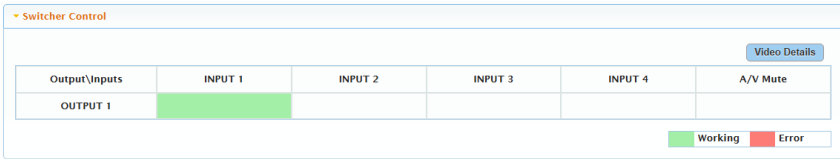

Users can select input for output in this section.

By default, INPUT 1 is selected as input source of HDMI output and HDBT receiver.

Click the button in the table to select the input for the output display (button turns from white to green once selection is done).

- **Video Details:** Click to enter the following page:

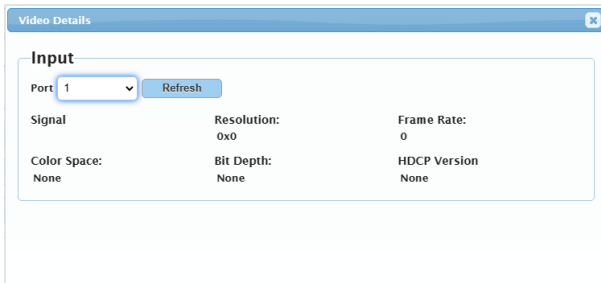

- **Port:** Select one input port to get its detail information such as resolution, Frame Rate, etc..
- **Refresh:** Click to refresh current information.
- **A/V Mute:** Click to mute the audio of video outputs.

2) USB Control

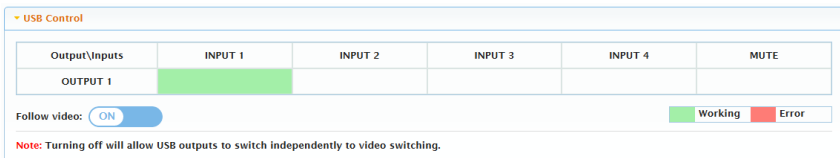

This section allows you to set USB control mode.

Follow video: Click the slider to set “Follow video” function to “ON/OFF”. By default, “Follow video” is set to “ON”.

HDMI2.0 KVM Switcher

- When it set to “ON”, USB HOST 1-4 are bound with HDMI IN 1-4 respectively, USB connections will follow the input source selection.
- When it set to OFF, users can switch USB connections independently through the upper table. For example, select HDMI IN 1 as input source for HDMI/HDBT OUT, and select USB host 2 to be connected to USB devices 1, the USB devices 1 will be connected USB host 2.

3) Audio Control

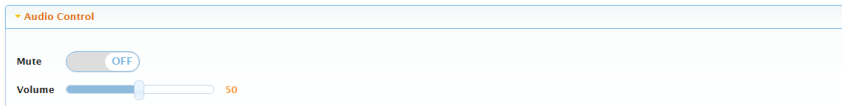

This section allows you to select de-embedded audio source for AUDIO OUT and set AUDIO OUT to mute/unmute.

- **Mute:** Click the slider to set AUDIO OUT to mute/unmute. By default, it is set to unmute.
- **Volume:** Drag the slider left or right to adjust the volume of AUDIO OUT. The default volume is 50.

4) Preset

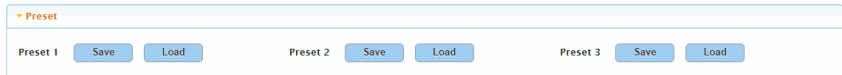

This section saves/loads the input/output switch settings to or from the switcher.

- **Save:** Settings in Video Control section are saved.
- **Load:** Preset already saved is loaded.

5.2.2. General Setting

There are three submenus in this page: EDID Preset, EDID Read, HDCP.

HDMI2.0 KVM Switcher

1) EDID Preset

▼ EDID Preset

Input	Preset	Input	Preset
INPUT 1	4K@60Hz 2.0ch PCM With SDR <input type="button" value="Apply"/>	INPUT 2	4K@60Hz 2.0ch PCM With SDR <input type="button" value="Apply"/>
INPUT 3	4K@60Hz 2.0ch PCM With SDR <input type="button" value="Apply"/>	INPUT 4	4K@60Hz 2.0ch PCM With SDR <input type="button" value="Apply"/>

This section allows you to configure EDID settings of each input port. Select the item from the drop-down menu, then click “Apply” to take effect. By default, input EDID is set as 4K@60Hz 2.0ch audio With SDR.

2) EDID Read

▼ EDID Read

Click “Enter” to open the EDID Setting page.

EDID Read ✕

HDMIOUT 1

Status:

	01	02	03	04	05	06	07	08	09	10	11	12	13	14	15	16
01																
02																
03																
04																
05																
06																
07																
08																
09																
10																
11																
12																
13																
14																
15																
16																

Select one output port from the drop-down menu for EDID setting.

- **Read:** Click to read the EDID of the Output port you choose.
- **Save As:** Click to save the read EDID of the output as a bin file to a desired location.

HDMI2.0 KVM Switcher

3) HDCP



The screenshot shows the HDCP configuration interface. It features a header with a dropdown arrow and the text "HDCP". Below this, there are four input ports labeled INPUT 1, INPUT 2, INPUT 3, and INPUT 4. Each port has a blue toggle switch that is currently in the "ON" position.

This section allows you to enable or disable HDCP capability of each input. By default, HDCP Support is switched to ON at each input to allow for HDCP-protected content transmission.

5.2.3. Advanced Setting

There are five submenus in this page: Network, Change Login Password, System Version, FW Update and System.

1) Network

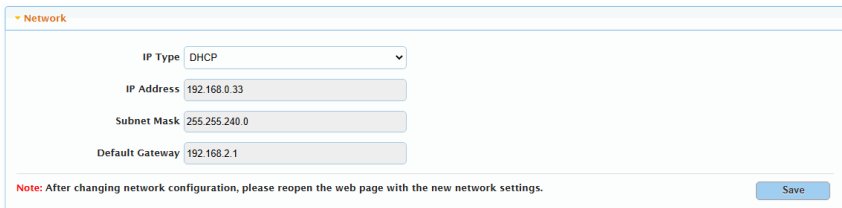

The screenshot shows the Network configuration page. It has a header with a dropdown arrow and the text "Network". The configuration fields are as follows:

- IP Type: DHCP (selected in a dropdown menu)
- IP Address: 192.168.0.33
- Subnet Mask: 255.255.240.0
- Default Gateway: 192.168.2.1

At the bottom, there is a red "Note" that reads: "After changing network configuration, please reopen the web page with the new network settings." and a blue "Save" button.

Network is used to toggle between the dynamic and static IP addressing.

- **DHCP:** When enabled, the IP address of the switcher is assigned automatically by the DHCP server connected.
- **Static:** When enabled, set up the IP address manually.
- **Apply:** Click to enable the network setting.

The default setting is DHCP.

Note:

- When "Static" is selected, please ensure your PC is in the same network segment as the switcher, i.e. the IP address of your PC should be set as 192.168.xxx.xxx (x is suggested among 2 to 253).
- After changing network configuration, please reopen the web page with the new network settings.

HDMI2.0 KVM Switcher

2) Change Login Password

Change Login Password

Old Password

New Password

Confirm New Password

Note: Password must be 4 to 16 characters in length, alphanumeric only.

Save

This section allows you to change login password.

The default password is “admin”.

Apply: Click to save the changes.

Note: The new password must be 4 to 16 characters in length (alphanumeric only).

3) System Version

System Version

Web UI (V1.0.0)

MCU (V1.0.0)

VS TX1 (V5.1.60)

This section shows the current web UI version MCU version and Valens version.

4) FW Update

FW Update

File:

Note: Do not power off the switcher when updating.

This section allows you to upgrade firmware of the switcher.

Steps to upgrade firmware:

1) Click “Browse” for the update file.

FW Update

File: SCT-SW/KVM411-H2U3_Whole_V1.0.0.zip

Note: Do not power off the switcher when updating.

2) Click "Update" to start the Firmware upgrade. Upgrading process will be showed as the following figures in sequence. It will upgrade MCU firmware

HDMI2.0 KVM Switcher

first, then Valens firmware, and at last ARM firmware. If one firmware is already the version need to upgrade, it will skip this firmware and upgrade next automatically.

Update Progress ✕

Transmitting MCU file 20%

20%

Update Progress ✕

Transmitting MCU file 100%

100%

Update Progress ✕

Upgrading MCU 100%

100%

Update Progress ✕

Upgrading VS3000, please wait

0%

Update Progress ✕

Upgrading VS3000 100%

100%

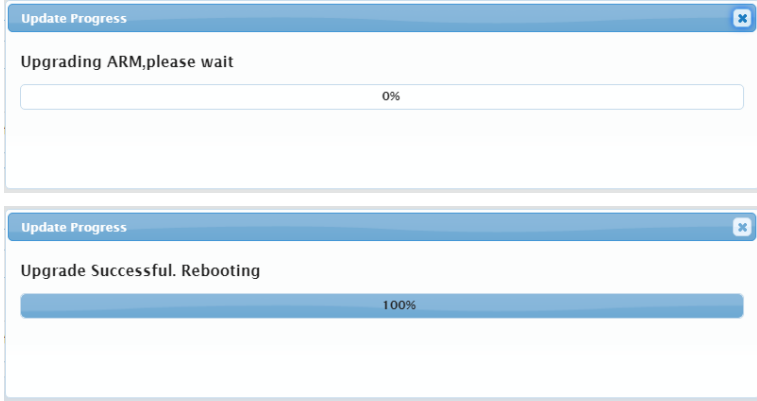

- 3) When the window of “Update Process” shows “Upgrade Successful. Rebooting” and the process bar reaches to 100% (as shown in the last figure in step 2), the upgrading process finishes and the switcher will reboot automatically. Please wait for about 30s and then refresh and log in again.

Note:

- Do not power off the device when upgrading.
 - The Valens firmware can be upgraded separately. The Valens upgrading steps are same with the previous upgrading steps.
- 1) Click “Browse” for the update file.

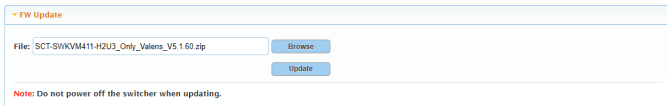

- 2) Click "Update" to start the Firmware upgrade. Do not power off the switcher during the upgrading process. Upgrading process will be showed as follows:

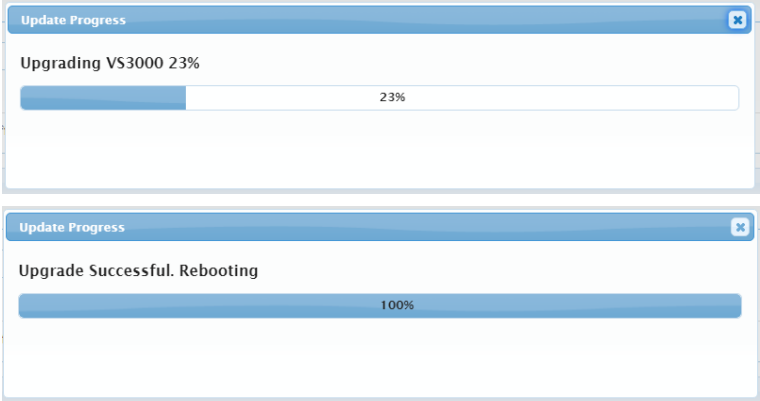

- 3) The switcher will upgrade and reboot automatically when upgrading firmware is completed. Please wait for about 30s and then refresh and log in again.

5) System

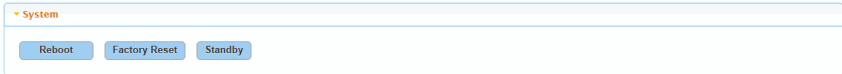

This section allows users to reboot, reset the switcher or set it to standby mode.

- **Reboot:** Click to reboot the device.
- **Factory Reset:** Click to reset the device to factory defaults.
- **Standby:** Click the button, a warning window will show as the following figure, the device will enter standby mode, and the web will back to login page after 10s.

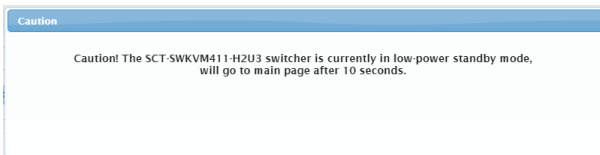

Note:

- Please wait about 1 minutes to re-access Web UI by refreshing the browser after reboot/reset the device.

HDMI2.0 KVM Switcher

- When in standby mode, enter the password in login page, the following window will pop up, users can select to exit standby mode or stay in this mode.

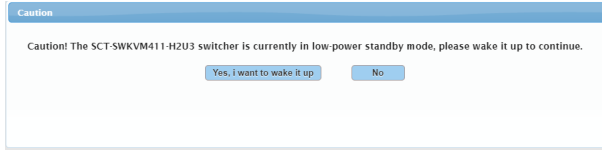

6. Customer Service

The return of a product to our Customer Service implies the full agreement of the terms and conditions hereinafter. These terms and conditions may be changed without prior notice.

6.1. Warranty

The limited warranty period of the product is fixed three years.

6.2. Scope

These terms and conditions of Customer Service apply to the customer service provided for the products or any other items sold by authorized distributor only.

6.3. Warranty Exclusion:

- Warranty expiration.
- Factory applied serial number has been altered or removed from the product.
- Damage, deterioration or malfunction caused by:
 - ✓ Normal wear and tear.
 - ✓ Use of supplies or parts not meeting our specifications.
 - ✓ No certificate or invoice as the proof of warranty.
 - ✓ The product model showed on the warranty card does not match with the model of the product for repairing or had been altered.
 - ✓ Damage caused by force majeure.
 - ✓ Servicing not authorized by distributor.
 - ✓ Any other causes which does not relate to a product defect.
- Shipping fees, installation or labor charges for installation or setup of the product.

6.4. Documentation:

Customer Service will accept defective product(s) in the scope of warranty coverage at the sole condition that the defeat has been clearly defined, and upon reception of the documents or copy of invoice, indicating the date of purchase, the type of product, the serial number, and the name of distributor.

Remarks: Please contact your local distributor for further assistance or solutions.



D i s t r i b u t i o n A G

syscomtec Distribution AG

Raiffeisenallee 8

D-82041 Oberhaching (bei München)

Tel.: +49 89 666 109 330

Email: post@syscomtec.com

<https://www.syscomtec.com>