

bottom view

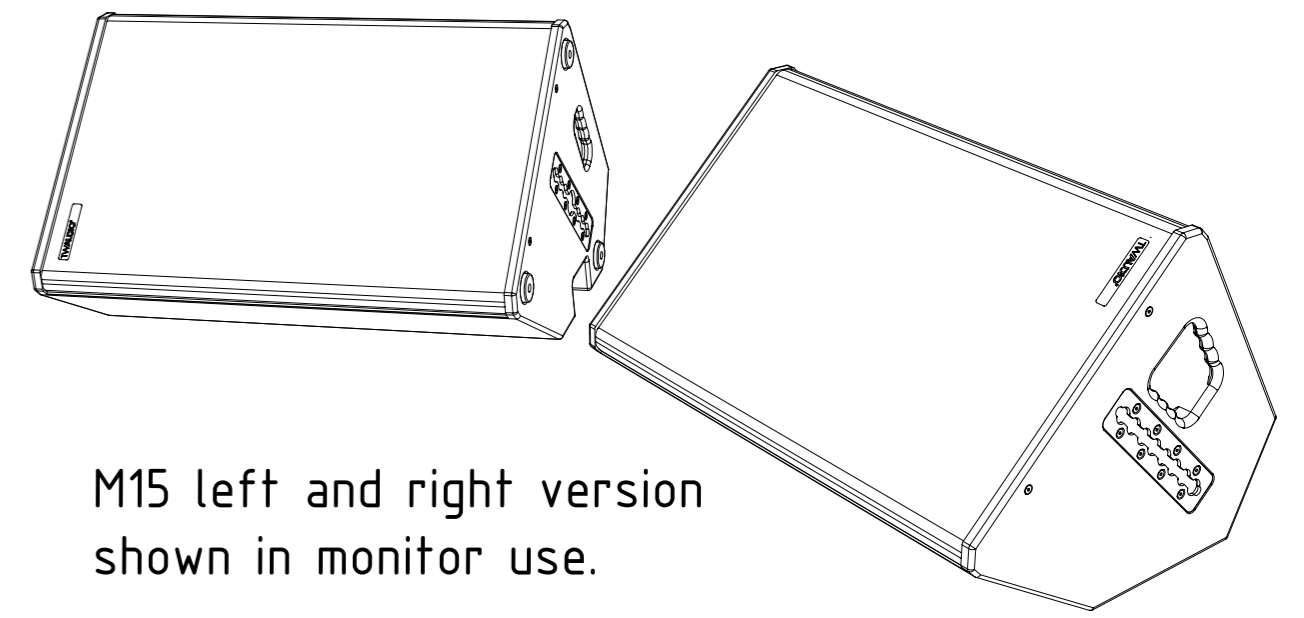

M15 left and right version shown in monitor use.

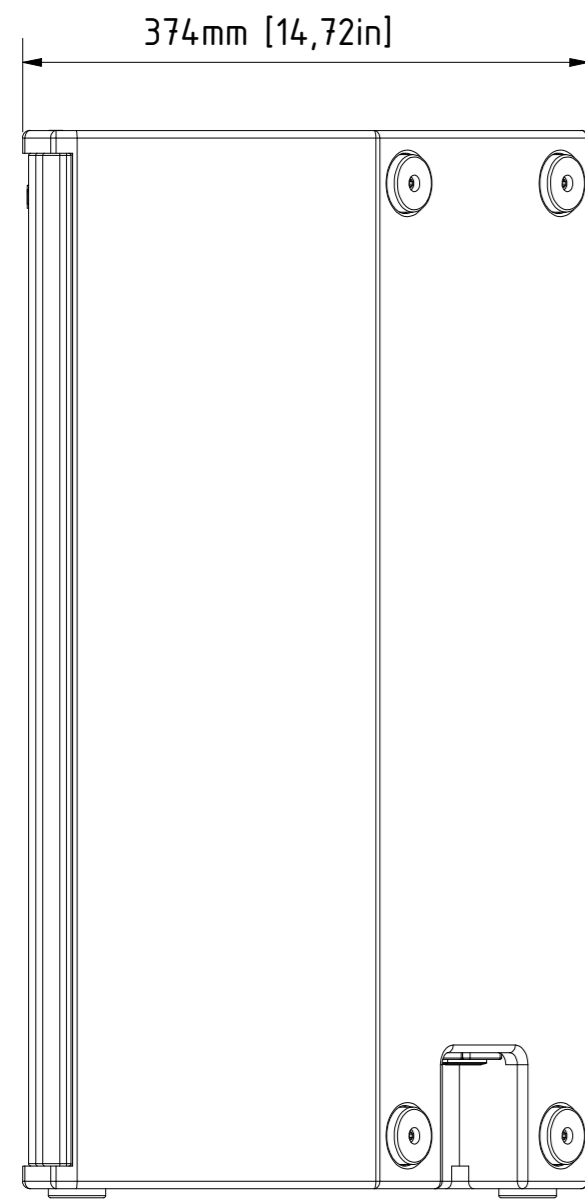

right view

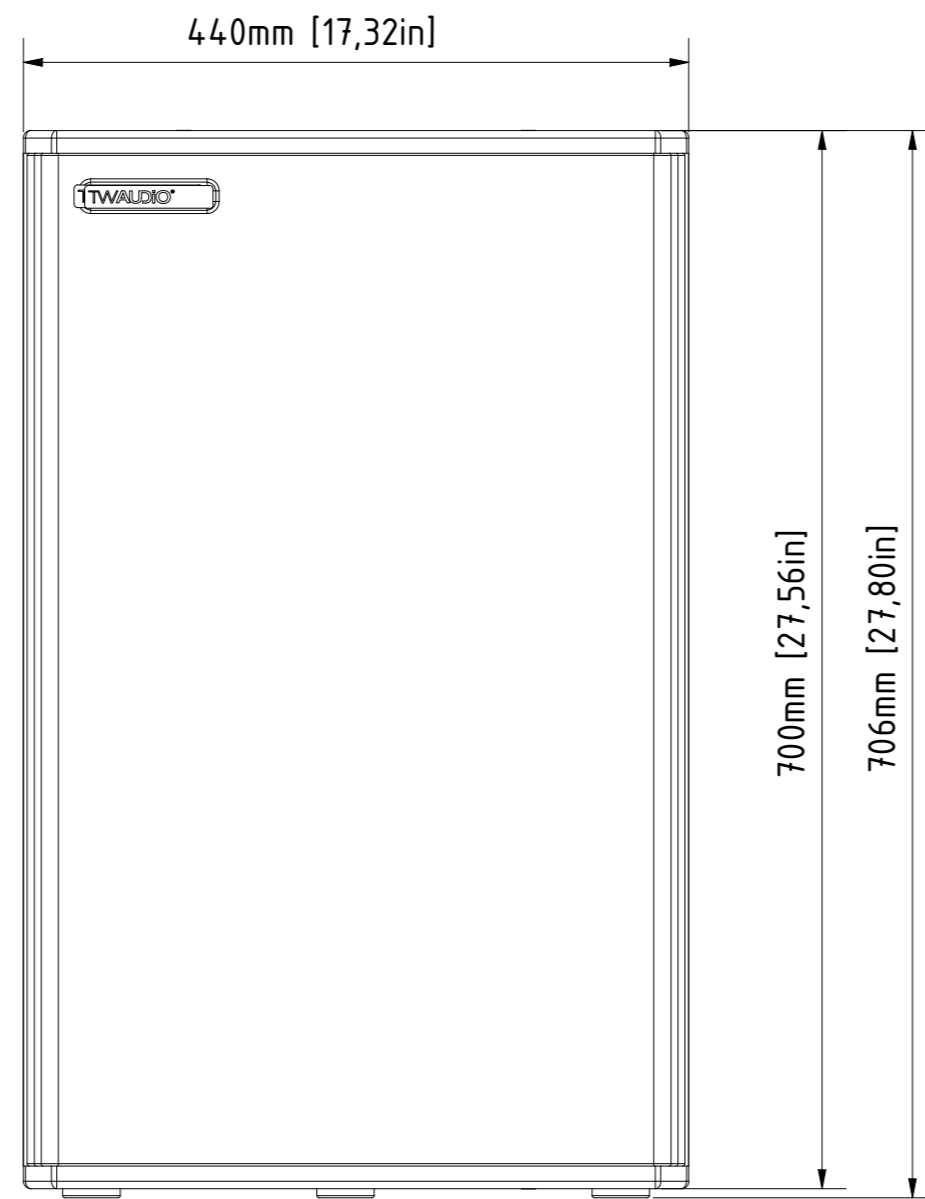

front view

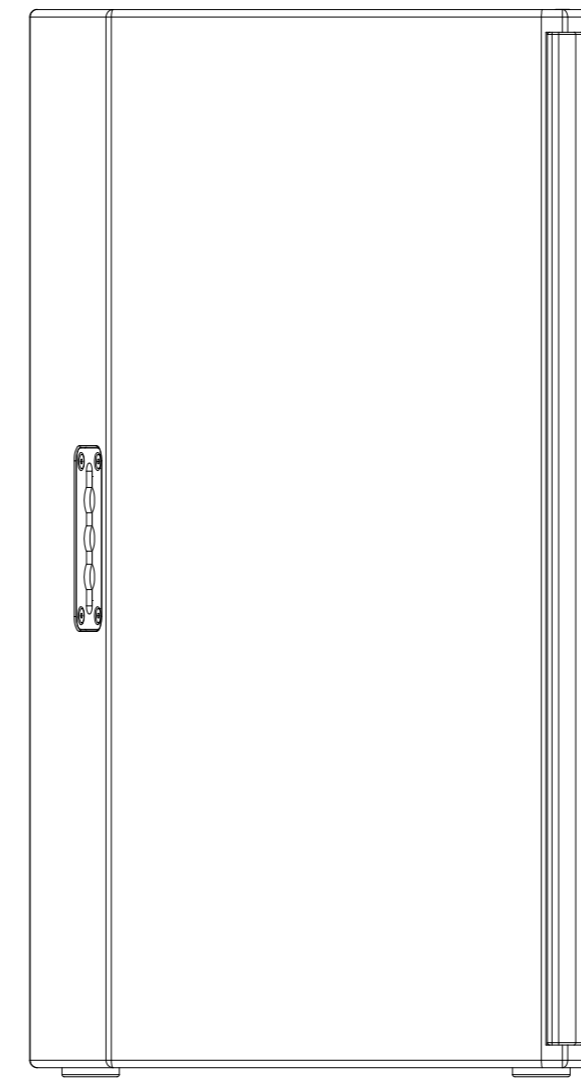

left view

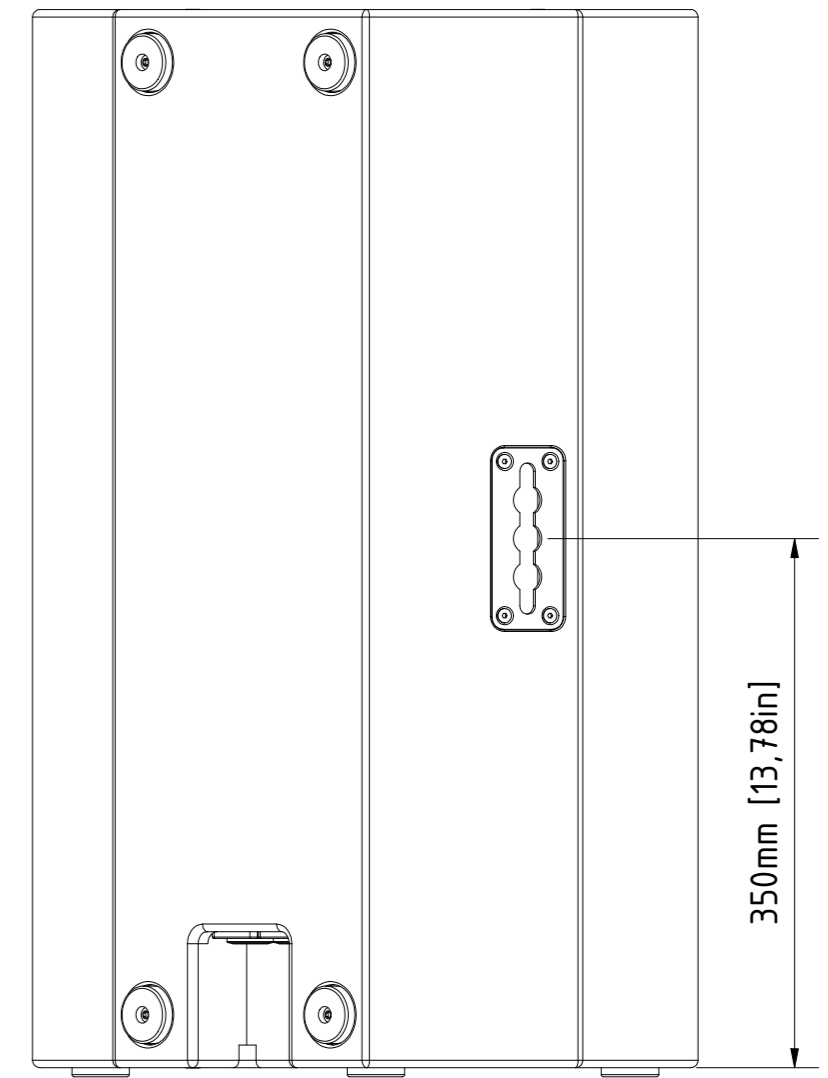

rear view

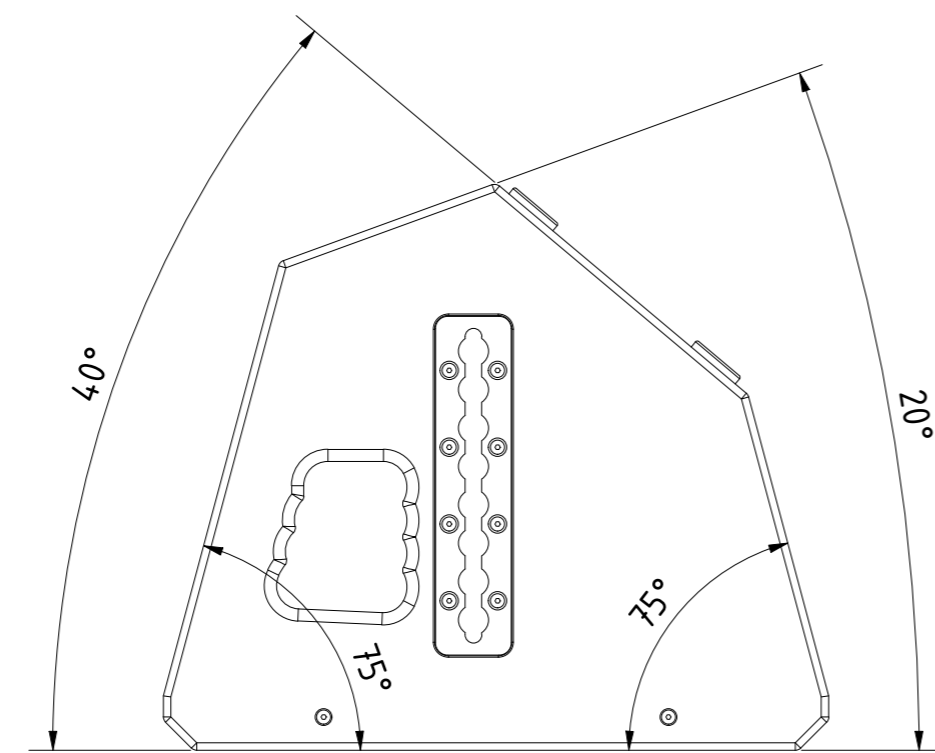
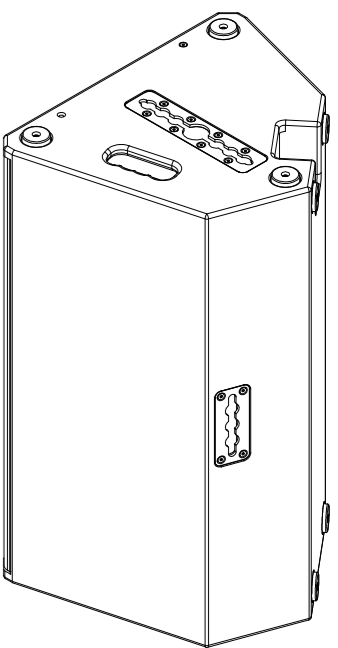

top view

0		06.05.2019	Heike Konrad
rev. no.		date	modified by
description			
revision process			
TWAUDIO Osterholzallee 140-2 71636 Ludwigsburg www.twaudio.de	scale:		
	weight:	24,9kg [55 lbs]	
	document type:	overview drawing	
	status type:	released	
All rights to this drawing reserved in accordance with ISO 16016. Copying and distribution by manufacturer's permission only.	date:	18.11.2009	Stefan Ullrich
	name:	M15	
	constructed:	18.11.2009	Stefan Ullrich
	drawn:	18.11.2009	Stefan Ullrich
checked:			
approved:	06.05.2019	Heike Konrad	
general tolerance	edges according to ISO 13715	drawing number:	
ISO 2768-mK	surfaces (Ra)	TWA-M15-0001	
ISO 13920-BF	array 2	revision no.:	0
ISO 9013-IIA/K	array 3	sheet:	1
according to ISO 8015	DIN ISO 1302	Az:	1