

FRONT

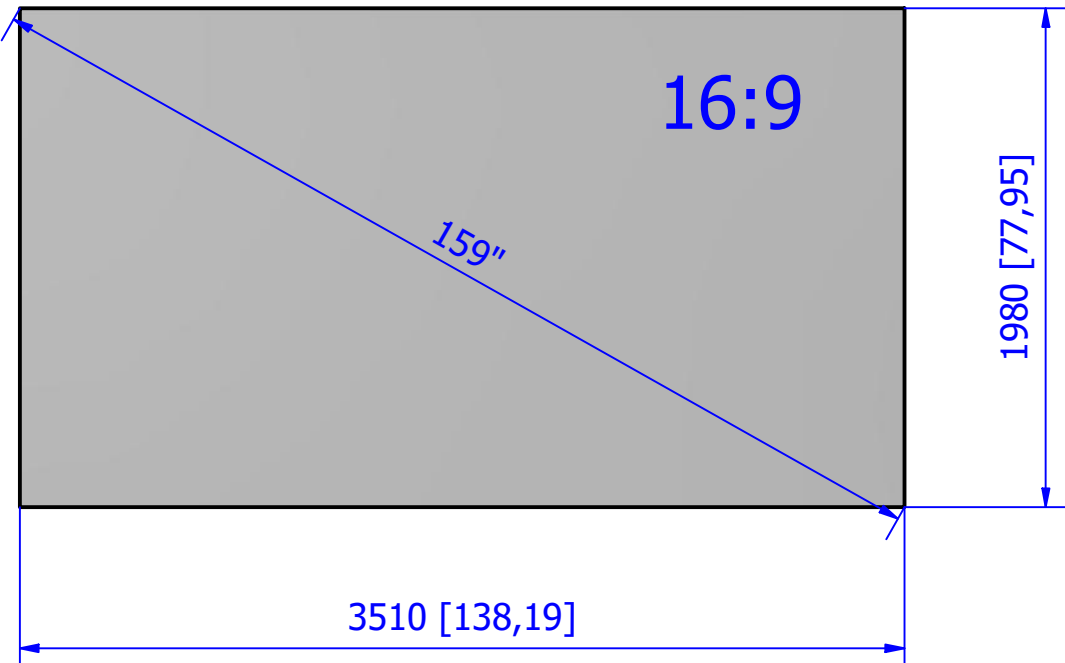

REAR

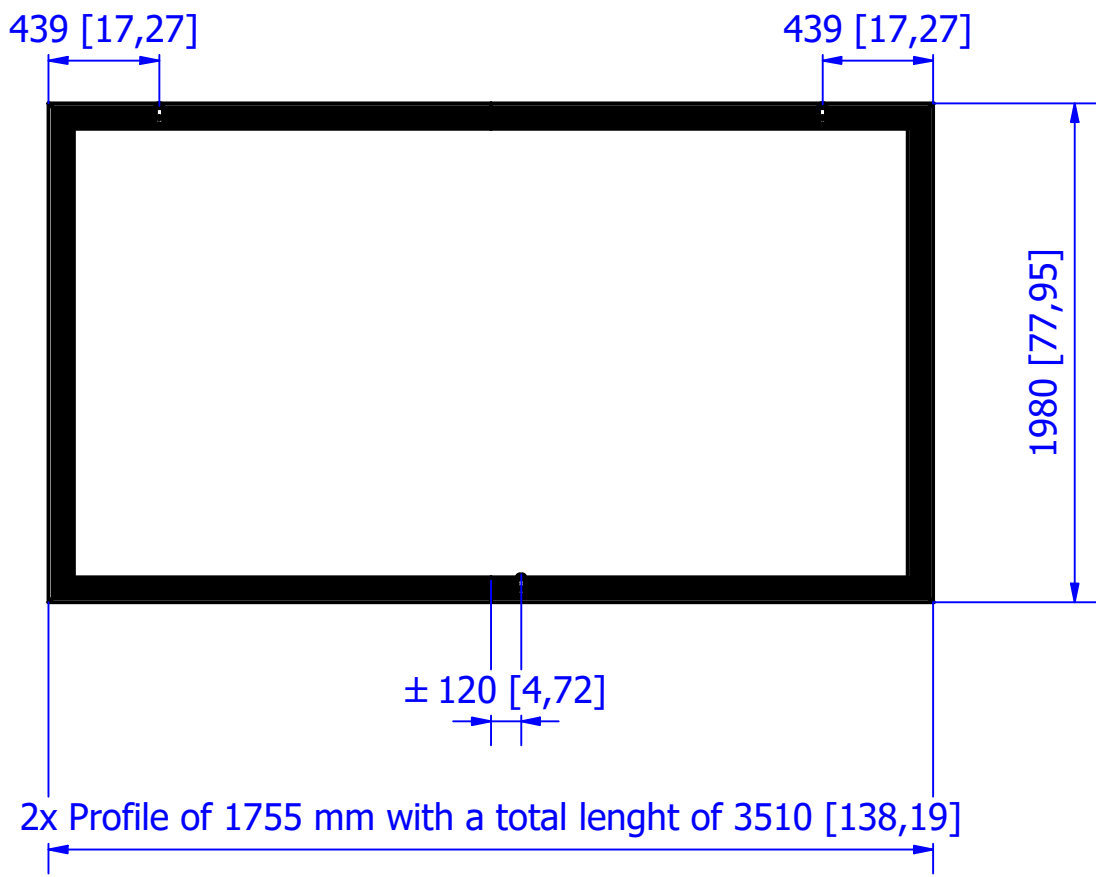

VIEWING SIDE

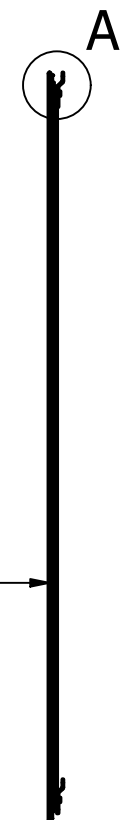

A (1 : 2)

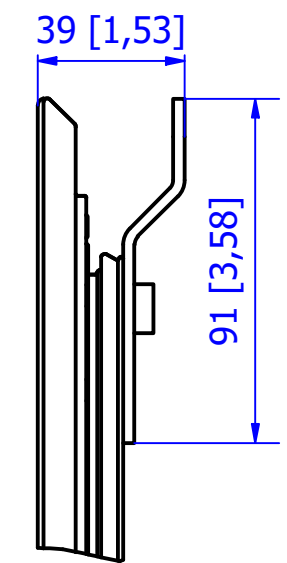

Dimensions are in mm [inch]

SCREENLINE

the screen makes the difference

Description: Living full vision 350x197			
Weight: 17 Kg	Code: UT-0005350	Drawer: F.Trainotti	Name: UT-0005350.iam
		Date: 14/07/2020	Sheet: A3
			Scale: 1 : 30

Please notice that all dimensions are subject to conventional industry tolerances.