

Highlights:

- Exceptional intelligibility and musical performance
- TwistFix™ borderless grill design
- Excellent off axis performance
- Flat frequency response
- Consistent sound profile throughout complete family
- Lifetime stability and toolfree installation with unique Quickfit™ innovation

Product information:

Designed to offer the best value for money ratio. The CIRA series are coaxial 2-way ceiling speakers featuring exceptional intelligibility and musical performance. The TwistFix™ borderless grill design offers easy but solid assembly and a completely seamless transition from grill to ceiling. This results in a perfect blend in to its environment. The QuickFit™ installation system combined with FastCon™ connector offers lifetime stability and great installers convenience.

The CIRA7 features a 6.5" driver using polypropylene cone material, combined with a 1" Mylar tweeter fitted with a phase plug for excellent off axis performance. The selected materials guarantee a low distortion performance with smooth and flat frequency response. A continuous power handling of 30 Watt (RMS) and maximum power handling of 60 watt is achieved, while fitted with a multi-tapping 100V line transformer with tapings for 24W, 12W, 6W and an 8 Ohm or 16 Ohm bypass connection.

Applications:

- Corporate
- Retail
- Bars & Restaurants

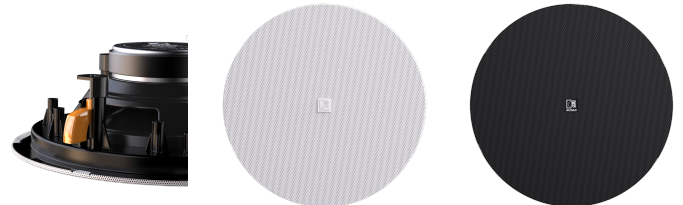

Impedance:

Ω 8 Ohm Ω 16 Ohm

Voltage:

⚡ 100 Volt

System specifications:

Peak power handling		120 W
Program power handling		60 W
RMS/AES power handling		30 W
Sound Pressure (Max. W/1m)	@ 100 V	103 dB
Sensitivity (1W/1m)		88 dB
Frequency	Response (± 3 dB)	55 Hz - 20 kHz
Speaker type		2-way coaxial
Impedance		8 Ω (CIRA724) 16 Ω (CIRA730D)
Frequency	Range (-10 dB)	45 Hz - 20 kHz
Dispersion	Conical	150°
Connectors		Multi-tap Fast-con™ connections
Drivers	HF	1"
	LF	6.5¼"
Line Transformer Tappings	1	24 W - 417 Ω (CIRA724)
	2	12 W - 833 Ω (CIRA724)
	3	6 W - 1667 Ω (CIRA724)

Product Features:

Cut-out measurement	200 mm (Ø)
Weight	1.45 kg (CIRA724) 1.35 kg (CIRA730D)
Operating temperature	-20 °C ~ 60 °C
Construction	ABS
Front finish	TwistFix™ borderless finely perforated steel grill
Built-in depth	78 mm (CIRA724) 75 mm (CIRA730D)
Mounting	QuickFit™ mounting system Fixture point for safety cable
Colours	White (RAL9003) (CIRA724/W& CIRA730D/W)
Dimensions	224 mm (Ø)

Variants:

- CIRA724I/W - White version, 8Ω & 100V (RAL9016)
- CIRA730D/W - White version, 16 Ω

Shipping & Ordering:

Packaging

Cardboard box

Architects' and Engineers' Specifications:

CIRA724 The ceiling mount loudspeaker shall be a 2-way coaxial type equipped with a 6.5" low frequency driver combined with an 1" mylar tweeter and fitted with a line transformer allowing it to be used on 100 Volt distributed line systems. It shall have an RMS power handling of 30 Watt with a maximum power handling of 60 Watt and the frequency response (± 3 dB) shall range from 55 Hz to 20 kHz. The sensitivity shall be 88 dB when measuring with an input signal of 1 Watt at a distance of 1 meter, while the maximum continuous sound pressure level shall be 103 dB. The nominal dispersion shall be a 150° conical coverage pattern at -6dB (average 100 Hz - 10 kHz). The loudspeaker shall fitted with a multi-tapping line transformer with tapings for 24 Watt, 6 Watt and 6 Watt including an 8 Ohm bypass. Fast and smooth connection of the system shall be possible using a Fast-con™ multi-tapping connector. The speakers frame shall be constructed in high quality ABS material and the front shall be finished through a borderless and finely perforated steel grill. A TwistFix™ borderless grill shall be provided, offering fast and stable assembly while guaranteeing seamless transition from grill to ceiling. It shall come available in both white (RAL9003) and black (RAL9005) colours and custom painting shall make it blend-in with any environment. Mounting of the speaker into the ceiling shall be possible using a 3-screw QuickFit™ installation system, a fixture point for an optional safety cable shall also be provided. The speaker shall have a diameter of 224 mm, a depth of 82 mm and the weight shall not exceed 1.41 kg. The speaker shall fit in a mounting hole with a cutout diameter of 200 mm and a build-in depth of 78 mm.

Polars:

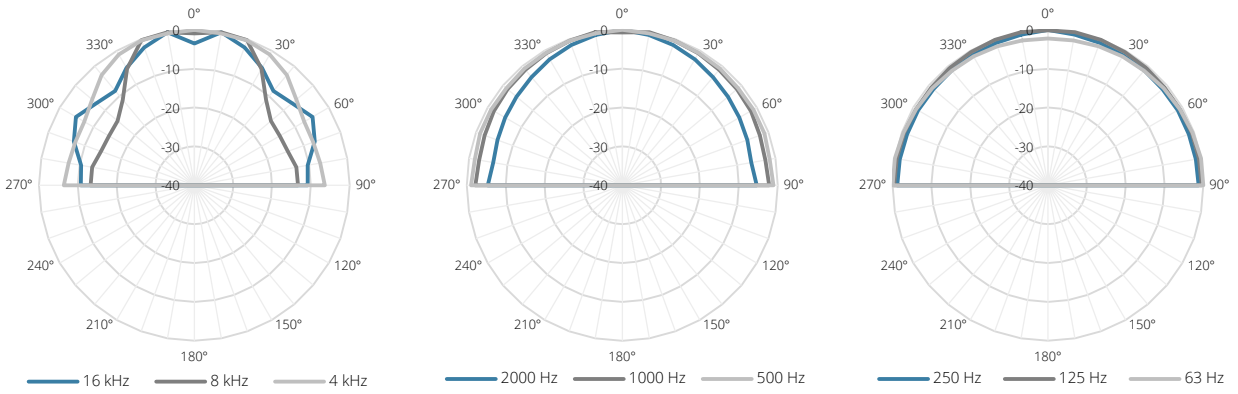

Sensitivity:

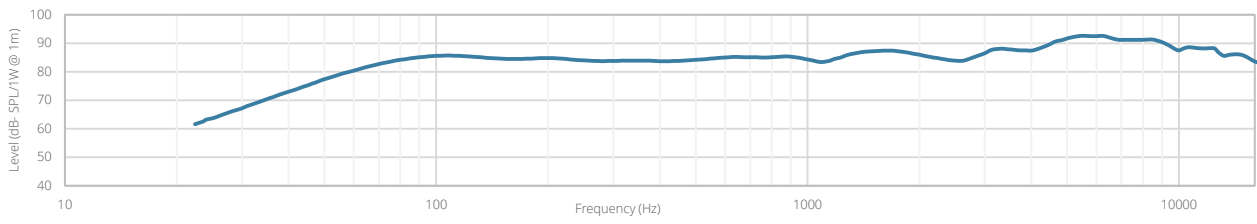

Beamwidth (-3dB):

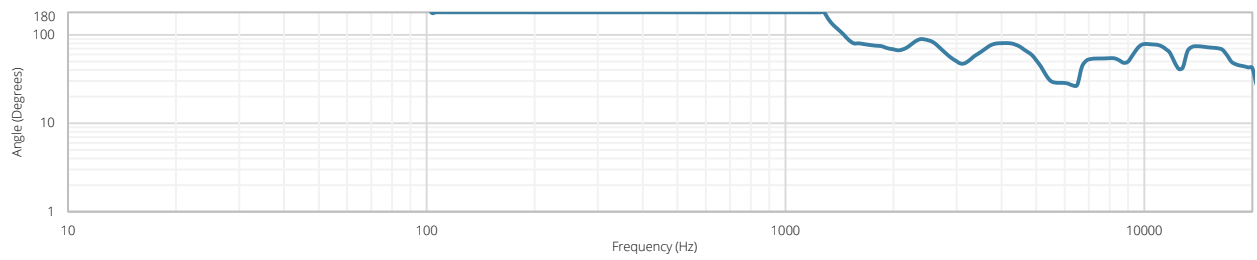

Directivity index:

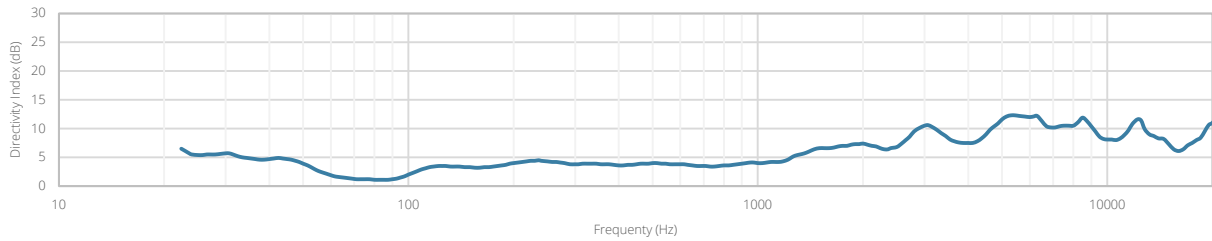

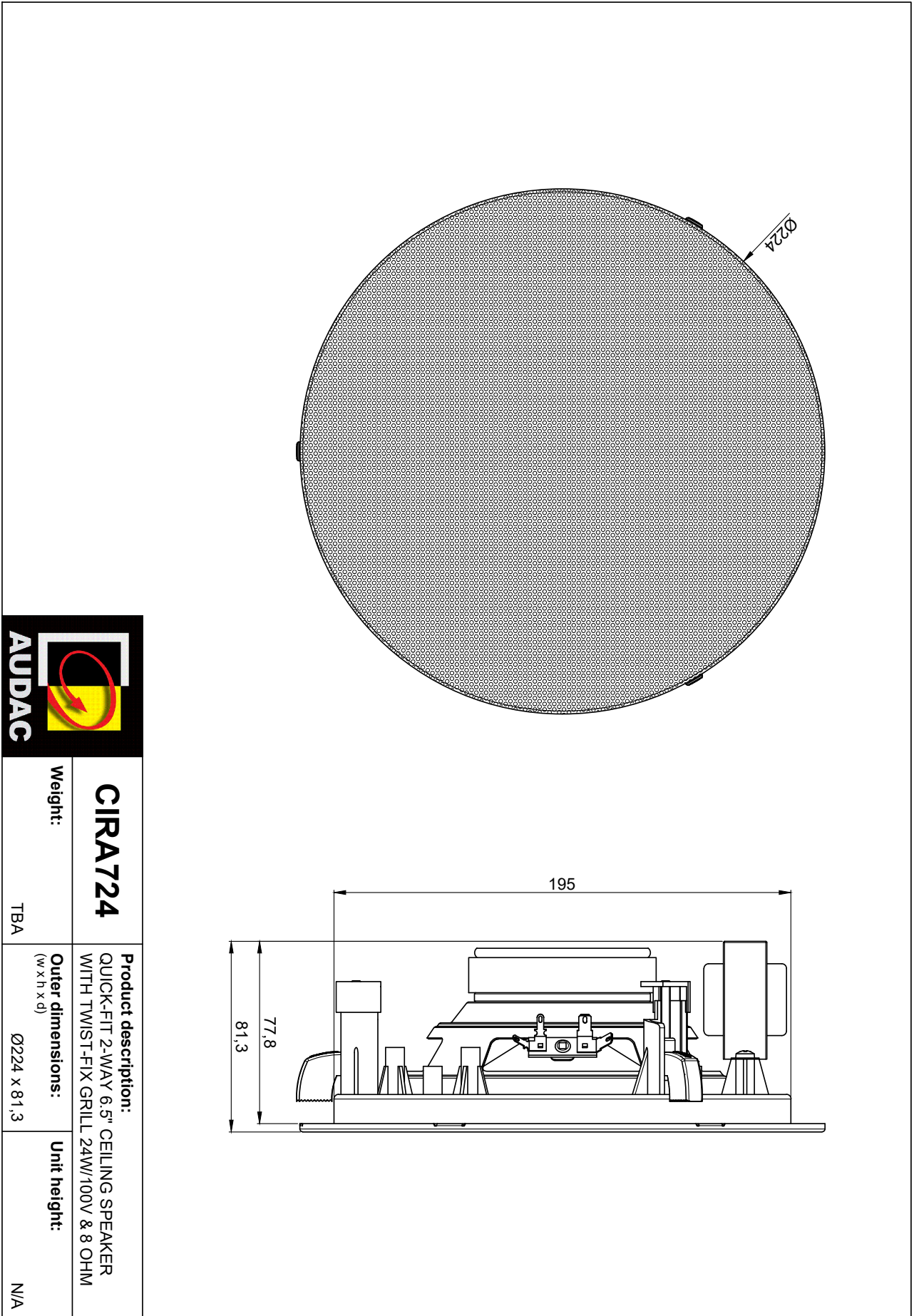

<p>CIRA724</p>	<p>Product description: QUICK-FIT 2-WAY 6.5" CEILING SPEAKER WITH TWIST-FIX GRILL 24W/100V & 8 OHM</p>	<p>Unit height: N/A</p>
<p>Weight: TBA</p>	<p>Outer dimensions: (w x h x d) Ø224 x 81,3</p>	

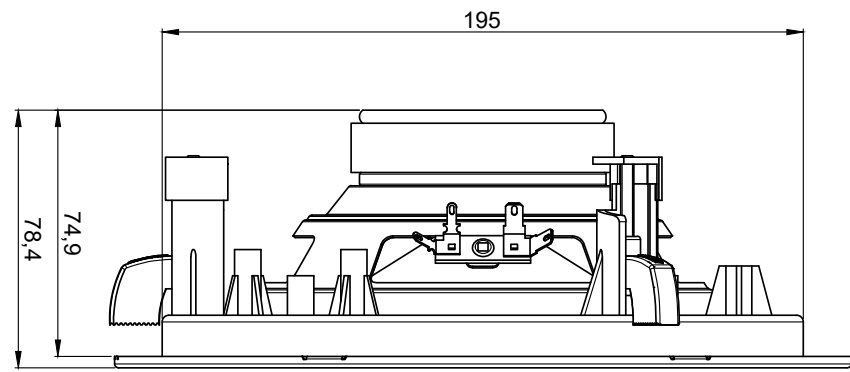
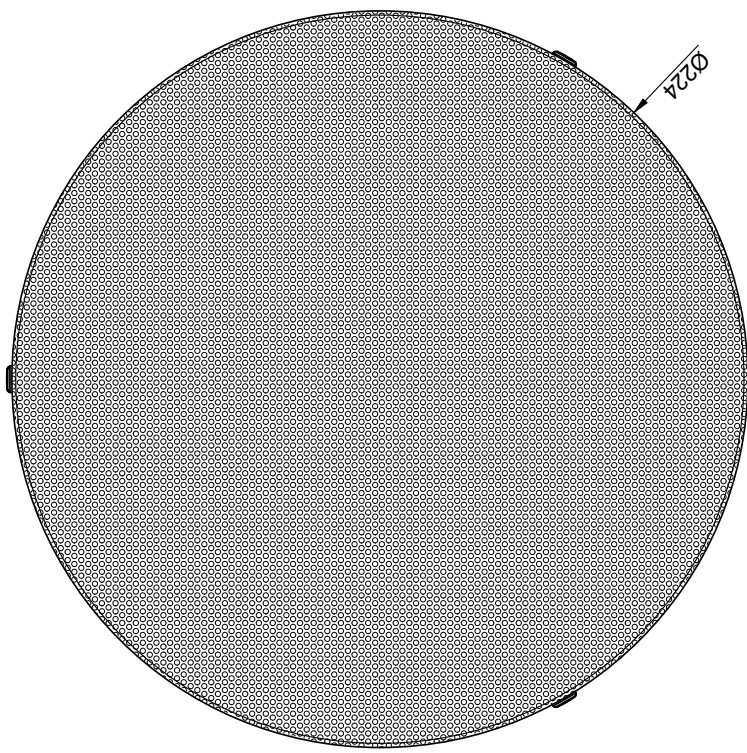

CIRA730D	Product description: QUICK-FIT 2-WAY 6.5" CEILING SPEAKER WITH TWIST-FIX GRILL 30W/16 OHM	Unit height: N/A
Weight: TBA	Outer dimensions: (w x h x d) Ø224 x 78,4	