



IDEAL FOR MOUNTING TO ANGLED CEILINGS

BT893-FD

FIXED DROP HEAVY DUTY PROJECTOR CEILING MOUNT WITH MICRO-ADJUSTMENT

Designed to mount projectors up to 70kg from the ceiling, the BT893-FD heavy duty projector is available in a range of fixed ceiling drop lengths and features an adjustable ceiling plate for use with angled ceilings. Easy adjustment of tilt, yaw and roll, with additional micro-adjustment at each corner makes alignment of projections quick and simple. The BT893 ideal for large scale and precision applications such as events and staging or for edge-blending and projection mapping.

SPECIFICATION	
Max load	70kg
Tilt (pitch)	+20° / -10° (+/- 5° with micro-adjustment)
Yaw (pole mounted)	45°
Roll	+/-5°
Ceiling plate tilt	90°
Max distance between fixings	873mm
Max distance (square fixing pattern)	618mm
Color option (Ø50mm pole)	Black, White or Chrome

FEATURES

- Designed to mount heavy duty projectors from the ceiling
- Features easy, incremented tilt adjustment
- Extendable mounting plate features 4-point micro-adjustment for perfect alignment of the projected images
- Micro-adjustment is altered using thumbwheels for better grip and a more controlled adjustment
- Quick and easy assembly
- Adjustable ceiling plate suitable for angled ceilings
- Optional extension legs can be used to accommodate larger fixing patterns
- Ø50mm pole is internally unobstructed for cables to pass through easily
- Suitable for projectors using M6, M8, M10 and M12 fixings



Available in 6 pole lengths

BT893-FD025	0.25m Pole
BT893-FD050	0.5m Pole
BT893-FD100	1m Pole
BT893-FD150	1.5m Pole
BT893-FD200	2m Pole
BT893-FD300	3m Pole

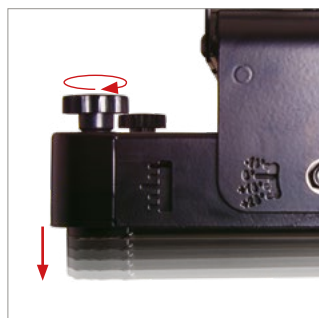
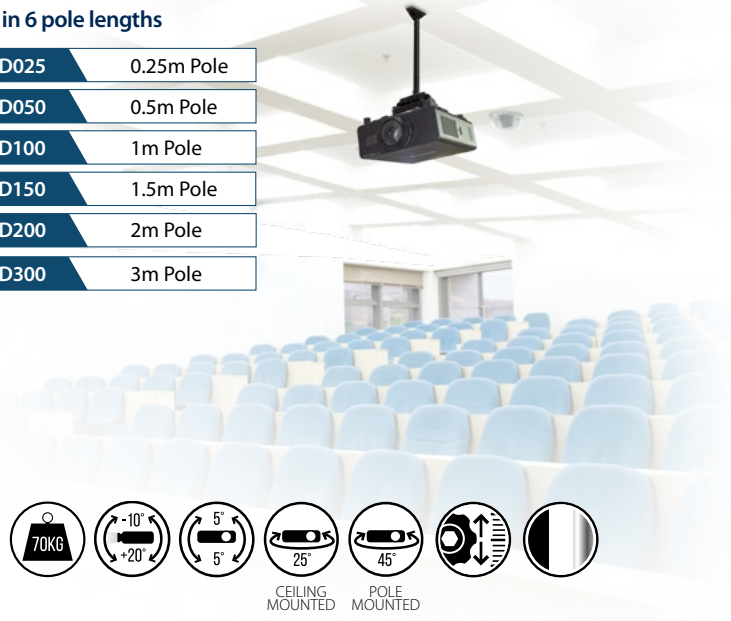

Micro-adjustment thumbwheels at 4-points for controlled and precise adjustment of the projector



Adjustable ceiling plate is ideal for angled ceiling installations



Features easy, incremented tilt adjustment



Optional extension legs are included to accommodate larger fixing patterns

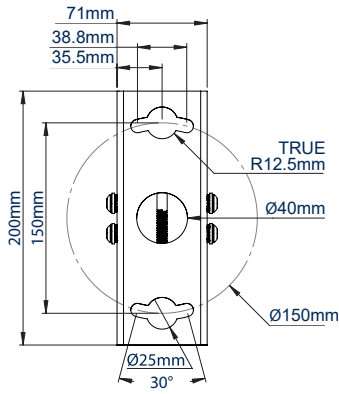

CEILING / WALL PLATE

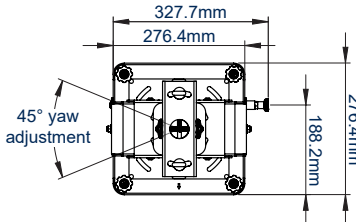

TOP VIEW

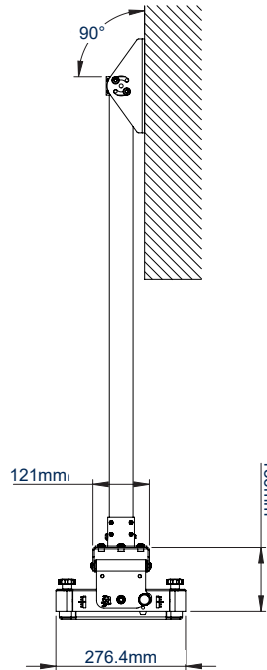

SIDE VIEW WALL MOUNTED

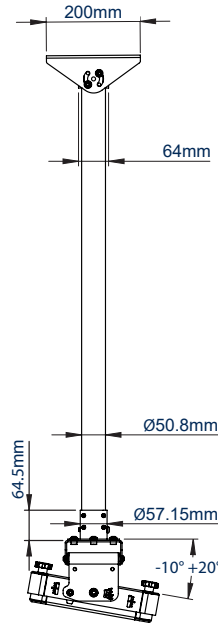

SIDE VIEW SHOWING TILT

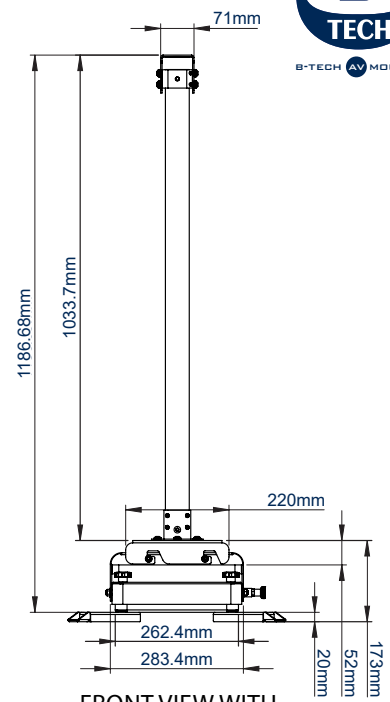

FRONT VIEW WITH EXTENSION LEGS

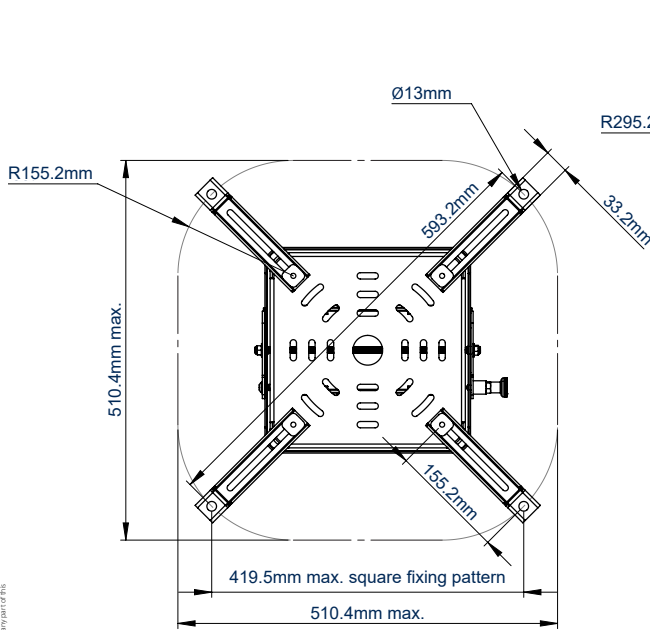

BOTTOM VIEW WITH SMALL EXTENSION LEGS

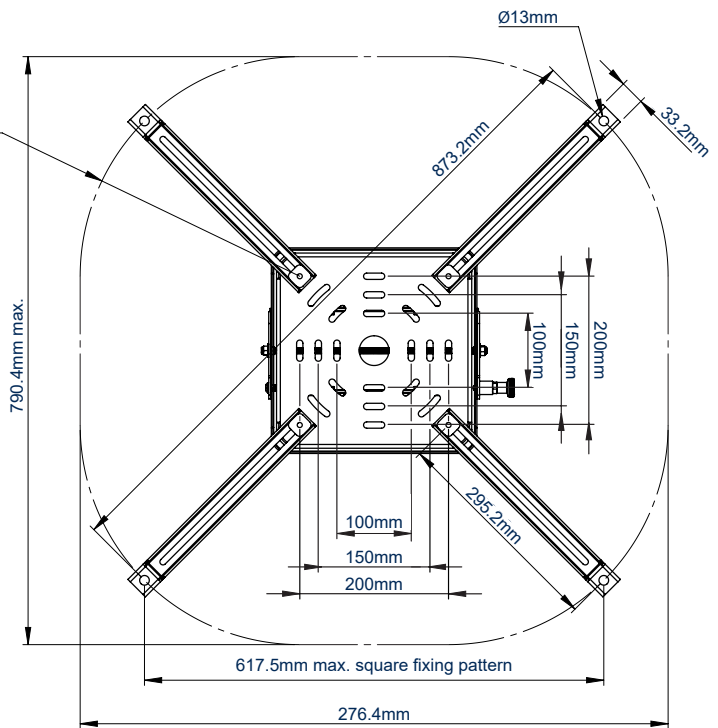

BOTTOM VIEW WITH LARGE EXTENSION LEGS

SIMILAR PRODUCTS

BT893-AD



Adjustable Drop Heavy Duty Projector Ceiling Mount for projectors up to 70kg

BT893



Heavy Duty Projector Ceiling Mount designed for projectors up to 70kg

BT897



Stackable Heavy Duty Projector Mount designed for projectors up to 75kg

BT898



Stackable Heavy Duty Projector Mount designed for projectors up to 75kg

© 2016 B-Tech Mounts Professional Design & Manufacturing Ltd. All rights reserved.
 The information in this specification is intended to provide a general overview of the product and its capabilities. It is not intended to be a contract. B-Tech Mounts Professional Design & Manufacturing Ltd. reserves the right to change the technical specifications without notice. This B-Tech Mounts Professional Design & Manufacturing Ltd. logo and name are registered trademarks of B-Tech Mounts Professional Design & Manufacturing Ltd.
 B-Tech Mounts Professional Design & Manufacturing Ltd. is not responsible for any damage or loss of data caused by improper use, installation or maintenance of the product. Any reproduction or modification of any part of this specification is strictly prohibited unless prior written permission has been granted by B-Tech Mounts Professional Design & Manufacturing Ltd. (B-Tech).
 SS-V2-BT893-FD-050819